

FIREYE® EPD380, EPD381, EPD382, EPD390 PROGRAMMER MODULES

AN ALTERNATIVE PROGRAMMER FOR USE
WITH THE FLAME-MONITOR™ SYSTEM



DESCRIPTION

The Fireeye EPD380, EPD381, EPD382, and EPD390 Programmer Modules are used with the FLAME-MONITOR™ Burner Management Control System. The operational characteristics are determined by the selection of the programmer. These characteristics include timing functions, switching sequences, and LED display.

The EPD programmers incorporate a series of seven (7) LED indicator lights to annunciate the current operating status of the FLAME-MONITOR control, as well as the reason for the last lockout condition. The EPD programmers include an RJ45 style connector to interface with a remote alphanumeric display (P/N ED510) and two (2) RJ style connectors to connect to an E500 communication interface. The EPD FLAME-MONITOR System can be upgraded to include an E300 Expansion Module (remote alpha-numeric display required). The system also provides a 0-10 VDC test jack signal (located on the front bezel) to indicate flame signal strength.

The EPD380, EPD381, EPD382, and EPD390 provide start-up programming, safe-start check, and flame monitoring supervision. They insure proof of low fire position and fuel valve end switch safety checks. A running interlock circuit on the FLAME-MONITOR system constantly monitors the limit switches, air flow switches, and fuel pressure switches through the programmer. The control recycles if any of these circuits are open at the improper point in the control cycle. The EPD380, EPD381, EPD382, and EPD390 programmer modules also provide the option that requires the 3-P running interlock circuit to be proven open at the start of the operating cycle. This option is selected via a switch located on the bottom of the programmer module. (See “3-P Running Interlock Circuit - Proven Open To Start”). A modulator (firing rate motor) circuit is not provided on the EPD380, EPD381, EPD382, and EPD390 Programmer Modules.

The programmer module will de-energize all fuel valve circuits within four (4) seconds (max.) following a flame failure, or at the end of the pilot trial for ignition period if no flame is detected. An alarm circuit will be energized following a safety lockout.

The EPD programmer is the heart of the FLAME-MONITOR System and incorporates a plug-in design for easy installation. It is microprocessor based and stores the burner cycle and on-time history that is accessible with the ED510 alpha-numeric remote display, E500 Communication Interface or Modbus communications. If replaced, the new programmer card will begin accumulating a new history.

Refer to Bulletin E-1101 for detailed information on the FLAME-MONITOR System.



WARNING: While all controls are mechanically interchangeable because they mate with a common wiring base, you must select the correct model for your application. Inappropriate application of a control could result in an unsafe condition hazardous to life and property. Selection of a control for a particular application should be made by a competent professional, such as a Boiler/Burner Service technician licensed by a state or other government agency.

TIMING CHARTS

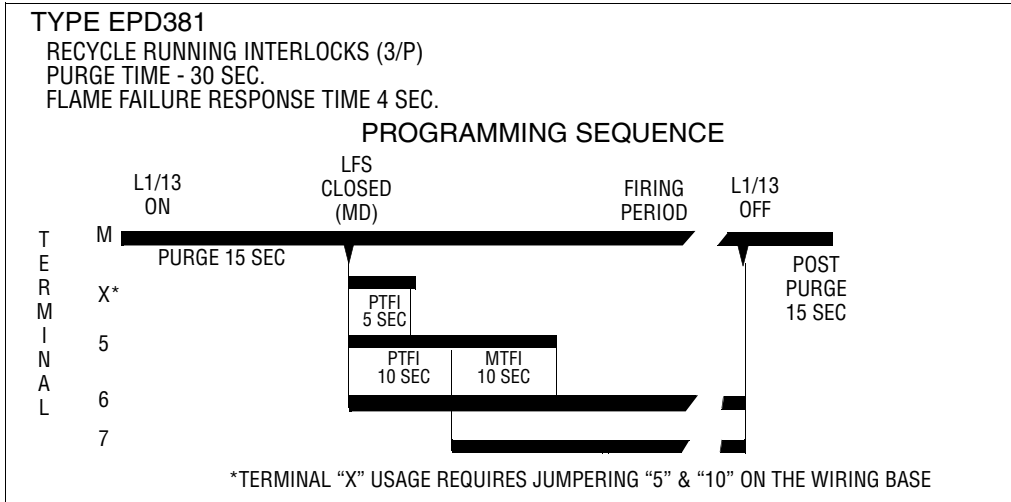
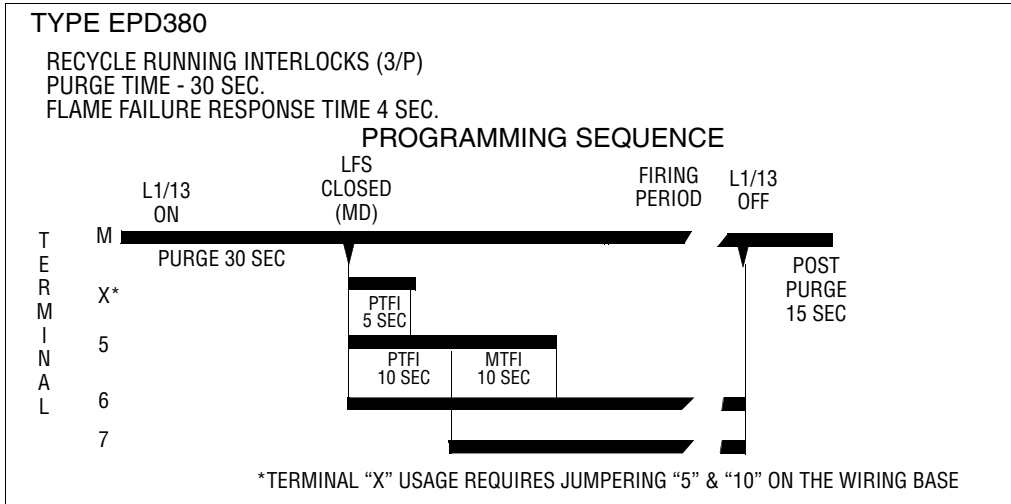

NOTE: All Programmings have a 2 second safe start check before initiating purge.

TYPE EPD382

RECYCLE RUNNING INTERLOCKS (3/P)
 PURGE TIME - 1 SEC.
 FLAME FAILURE RESPONSE TIME 4 SEC.

PROGRAMMING SEQUENCE

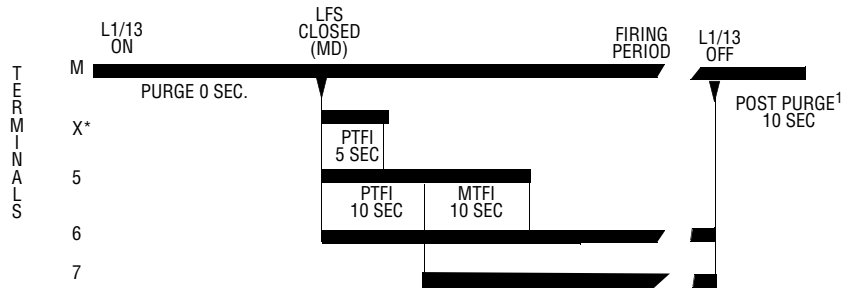

*TERMINAL "X" USAGE REQUIRES JUMPERING "5" & "10" ON THE WIRING BASE

TYPE EPD390

RECYCLE RUNNING INTERLOCKS (3/P)
 PURGE TIME - 90 SEC.
 FLAME FAILURE RESPONSE TIME 4 SEC.

PROGRAMMING SEQUENCE

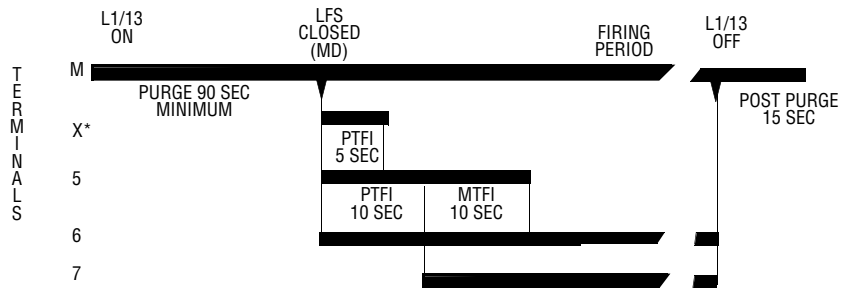

*TERMINAL "X" USAGE REQUIRES JUMPERING "5" & "10" ON THE WIRING BASE

NOTE: All Programmers have a 2 second safe start check before initiating purge.

¹ Programmer provides 15 second post purge following a safety lockout.

TABLE 1.

| OPERATING TEMPERATURE LIMITS | | | | |
|--|--------------------|-------|---------|-------|
| CONTROL | MAXIMUM | | MINIMUM | |
| | E110, EB700, EB701 | 140°F | 60°C | -40°F |
| EP, EPD Programmers | 140°F | 60°C | -40°F | -40°C |
| All Amplifiers | 140°F | 60°C | -40°F | -40°C |
| ED510 Display | 140°F | 60°C | 32°F | 0°C |
| Scanner UV1A, UV2, UV8A, 45UV3 | 200°F | 93°C | -40°F | -40°C |
| 45UV5-1007, 45UV5-1009 55UV5-1007, 55UV5-1009 | 200°F | 93°C | -40°F | -40°C |
| Flame Rod (Tip 2460° F) | 1500°F | 816°C | -40°F | -40°C |
| 48PT2 | 125°F | 52°C | -40°F | -40°C |
| Humidity: 85% R.H. (Non-condensing) | | | | |

INSTALLATION

Remove power from its wiring base before proceeding. Remove the control from the wiring base. If the control is a E100 FLAME-MONITOR control, remove the alpha-numeric display (ED500) and Type EP programmer module (e.g.: EP160). If the control is a D-Series style control, replace the entire D-Series control (chassis, programmer, and amplifier) with the FLAME-MONITOR type control.

The EPD programmer modules are used with the Fireeye E110 base chassis. They are installed in the chassis by inserting the EPD programmer module into the second slot on the control. This slot is marked "Programmer Module" on the side of the chassis.

***NOTE:** The EPD programmer modules use two slot positions on the EB700 chassis ("Programmer Module" and "Display Module"). An ED510 alpha-numeric display can be added remote to the FLAME-MONITOR and EPD programmer.*

EPD programmer modules are designed to fit only in the proper slot. They cannot be snapped into place if inserted in the wrong location. **DO NOT FORCE THEM.**

An amplifier module and flame scanner are also required for the FLAME-MONITOR control.

Wiring Considerations for Remote Meter



CAUTION: When connecting a remote meter to the test jacks located on the front of the EPD programmer module, care should be taken to insure the remote meter wiring leads are at least twelve (12) inches away from any high ignition source (e.g.: cables for ignition transformer).

Failure to follow this recommendation could cause the control to lockout and display the message "lockout scanner noise" or cause the control to freeze up, requiring the interruption of power to the control to reset the condition.

ORDERING LED INDICATOR LIGHTS:

Table 2:

| EPD Programmer Module | | | | | | |
|-----------------------|---------------|---------|-----------------|---------|--------------|------------------|
| PART NO. | USED WITH | PURGE | IGNITION TIMING | | | FFRT |
| | | | | PTFI | MTFI | |
| EPD380 | EB700 E110 | 30 Sec. | Term X | 5 Sec. | | 4 Sec. (max.) |
| | | | Term 5 | 10 Sec. | 10 Sec. | |
| | | | Term 6 | 10 Sec. | Intermittent | |
| EPD381 | EB700 E110 | 15 Sec. | Term X | 5 Sec. | | 4 Sec. (max.) |
| | | | Term 5 | 10 Sec. | 10 Sec. | |
| | | | Term 6 | 10 Sec. | Intermittent | |
| EPD382 | EB700 E110 | 0 Sec. | Term X | 5 Sec. | | 4 Sec. (max.) |
| | | | Term 5 | 10 Sec. | 10 Sec. | |
| | | | Term 6 | 10 Sec. | Intermittent | |
| EPD390 | EB700 E110 | 90 Sec. | Term X | 5 Sec. | | 4 Sec. (max.) |
| | | | Term 5 | 10 Sec. | 10 Sec. | |
| | | | Term 6 | 10 Sec. | Intermittent | |







FFRT is the maximum Flame Failure Response Time
NOTE: All modules have a recycle running interlock circuit (3/P)

The EPD programmer modules have seven (7) LED indicator lights to annunciate the operating status of the control, as well as provide the reason for the last lockout condition. Each LED has a graphic symbol to describe its function (see Table 3).

| | |
|--------------|--|
| ALARM | In the event of a lockout condition, the Alarm LED will blink, the remaining LED's will light up to indicate the lockout condition. See "Safety Lockout Codes." |
| FAN | Lights when the blower motor is energized (terminal M) and flashes when the RUN/CHECK switch is in the "Check" position during purge, PTFI, and AUTO |
| OPEN DAMPER | This LED is only used to annunciate a lockout code. See Page 8. |
| CLOSE DAMPER | Will blink when the modulator motor is being driven to the low fire position (circuit 10-12 made). Once the low fire switch closes (M-D), this LED will light constant. This LED provides the status of the low fire start interlock circuit (M-D). This LED lights anytime the M-D circuit closes during pre-purge, PTFI, MTFI, post purge. |
| IGNITION | Will blink during Pilot Trial For Ignition (PTFI). Will light constant during Main Trial For Ignition (MTFI). |
| AUTO | Blinks when the RUN/CHECK switch is in the "Check" mode during the run period. |
| FLAME | Will light whenever flame is detected by the flame scanner. |

BLINKING LED'S: When the burner is off, the LED's will blink in succession every 60 seconds to indicate the off condition. Pressing the Reset button with the burner off will also blink the LED's in succession.

Table 3:

| | | | | | | |
|---|---|---|---|---|---|---|
| ALARM | FAN | OPEN DAMPER | CLOSE DAMPER | IGNITION | AUTO | FLAME |
|  |  |  |  |  |  |  |



OPERATION

Refer to the wiring suggestions shown on page 9 proceeding to power the FLAME-MONITOR control. Refer to Bulletin E-1101 for items such as scanner installation, short circuit tests and additional safety information.

Note that for direct spark ignited oil burners, substitute the words “main oil valve” for “pilot valve.”

Important: If a remote alpha-numeric display is also installed, the display will scroll a history message for 15 seconds on initial power-up and restarts following a power failure.

3-P RUNNING INTERLOCK CIRCUIT - PROVEN OPEN TO START:

The EPD380, EPD381, EPD382, and EPD390 programmer modules provide the option that requires the 3-P running interlock circuit to be proven open at the start of the operating cycle. If this option is enabled, the 3-P running interlock circuit **MUST be open** at the start of the operating cycle (L1- 13 circuit closed). If this option is enabled and the 3-P circuit is closed at the start of the operating cycle, the control will hold for one (1) minute waiting for the 3-P circuit to open. The blower motor (terminal M) will not be energized until the 3-P circuit opens. The “Fan” and “Auto” LEDs will blink until the 3-P circuit opens. If after one (1) minute, the 3-P circuit does not open, the control will lockout and display the lockout code for “3-P RUN INTERLOCK CLOSED.” This option is enabled or disabled via a switch located on the bottom of the programmer. The programmers are shipped with this option disabled.

SETUP OF DAMPER MOTOR LOW-FIRE END SWITCH

The “Close Damper” LED provides positive indication of the position of the damper motor low fire end switch during Purge, PTFI, MTFI, Post Purge, and when the “Check/Run” switch is in the “Check” position. This feature allows easy set-up and proper adjustment of the modulating motor low fire end switch.

START-UP (Normal Cycle):

1. Constant 120 VAC should be available to terminals L1 and L2 on the wiring base.
2. The operating control circuit (L1-13) will close, signaling the burner to start its firing sequence.
3. If the 3-P Open To Start switch is enabled, the 3-P circuit must be open before the cycle will continue. See (3-P RUNNING INTERLOCK CIRCUIT - PROVEN OPEN TO START).
4. Assuming the fuel valve end switch (13-3) is closed, the burner/blower motor (terminal M) circuit is energized. **The “Fan” LED will light.** The running interlock (limit) circuit (3-P) will close provided there is sufficient purge air available and all remaining interlocks are closed.
5. The EPD380 provides a 30 second purge, the EPD381 provides a 15 second purge, the EPD 382 provides a 1 second purge, and the EPD390 provides a 90 second purge. All pre-purge times are preceded by a 2 second safe start check.
6. When the pre-purge is completed, the control will wait for the low fire switch (M-D) to close. When the switch closes, **the “Close Damper” LED will light constant**, and the trial for ignition sequence will start. If the M-D circuit does not close, the program will hold in this position for ten (10) minutes waiting for the circuit to close. If it does not close, the control will lockout.
7. When the purge is completed and the low fire start switch (M-D) closes, the Pilot Trial for Ignition (PTFI) period begins with the terminals X*, 5 and 6 being energized simultaneously. **The “Ignition” LED will blink.** This period is ten (10) seconds in duration.

***NOTE:** Terminal X is only energized for 5 seconds during the PTFI period. If flame is detected during the 10 second PTFI period, the “Flame” LED will light, and the MTFI (Main Trail for Ignition) sequence will start. If no flame is detected after ten seconds, the control will de-energize terminals 5 and 6 and lockout.*

** **NOTE:** The use of terminal “X” as an ignition terminal requires placing a jumper between terminals “5” and “10” on the wiring base.*



- When flame is detected, the test meter jacks on the front of the EPD display will provide an indication of flame signal strength. A remote alpha-numeric display will also provide a readout of the flame signal strength.

TABLE 4.

| | Test Meter Jacks | Alpha-Numeric Display |
|--------------------|------------------|-----------------------|
| Minimum Acceptable | 3.0 VDC | 6-16 |
| Normal | 4.0-10.0 VDC | 20-80 |

- With flame proven at the end of PTFI, the main flame trial for ignition (MTFI) begins and terminal 7 is energized. The **“Ignition” LED will light constant**. Terminal 5 is de-energized ten (10) seconds later. Terminal 6 will remain energized during the entire firing period.
- At the end of MTFI period, the **“Ignition” LED goes out**. The test meter jacks and remote alpha-numeric display will provide an indication of flame signal strength.

NORMAL SHUTDOWN

- When the operating control circuit (L1-13) opens, the main fuel valve is de-energized and the **“Flame” LED goes out**.
NOTE: If any flame is still detected by the flame scanner, the “Flame” LED will remain lit.
- Following the post purge, the burner/blower motor is de-energized. The **“Fan” LED goes out**. The EPD380, EPD381, and EPD390 provide a 15 second post purge. The EPD382 provides a 10 second post purge.
- The burner is now off. The LED's shall blink in succession every 60 seconds to indicate the off condition. Pressing the Reset button with the burner off will also blink the LED's in succession.

SAFETY SHUTDOWN







In the event of a lockout condition, the **Alarm LED will light**. See “Resetting a Lockout” on page 8.

- If the low fire start switch (M-D) or running interlock circuit (3-P) have not closed after a ten (10) minute “Hold” period during prepurge, the control will lockout and the blower motor will be de-energized. If the interlock circuit opens during the trial for ignition period or firing period, all fuel valves will be de-energized, the control will initiate a 15 second post purge (10 second post purge for the EPD382), **and then recycle**. See above for condition of running interlock circuit during prepurge.
- If the 3-P Open To Start switch is enabled, and the 3-P circuit is closed at the start of the operating cycle, the control will hold for one (1) minute waiting for the 3-P circuit to open. If after one (1) minute, the 3-P circuit does not open, the control will lockout.
- If pilot flame is not detected during the 10 second trial for ignition period, the pilot valve and ignition transformer will be de-energized and the control will lockout.
- If main flame is not detected for a continuous four (4) second period during the main trial for ignition period, all fuel valves will be de-energized and the control will lockout.
- If the main flame fails during a firing cycle, all fuel valves will be de-energized within four (4) seconds (max.) after loss of flame signal and the control will lockout.
- If flame is seen at an improper time once the blower motor is energized (e.g.: during purge), the control will lockout within four seconds.
- If flame is detected while the operating control (L1-13) is open, the **“Flame” LED will light** and if the flame signal (real or simulated) is still present after sixty (60) seconds, the control will lockout.
- If the operating control (L1-13) closes and flame is still detected, the control will not energize the blower motor but will wait for the flame signal to go away. If after sixty (60) seconds, the flame signal is still present, the control will lockout. If the flame signal goes away within 60 seconds after the operating control closes, the control will energize the blower motor and proceed with a normal start-up.

RESETTING A LOCKOUT⁴

In the event of a lockout condition, the Reset button must be pressed and released to reset the lockout. When a lockout occurs, only the Alarm LED is initially lit and blinks while the remaining LED's indicate the cause of lockout.

NOTE: The Reset button must be pressed and released for the control to recognize the button.

| LOCKOUT MESSAGE | LED DISPLAY READOUT ● = ON | | | | | | DESCRIPTION |
|------------------------------------|---|---|---|---|---|--|---|
| | FAN | OPEN DAMPER | CLOSE DAMPER | IGNITION | AUTO | FLAME | |
| |  |  |  |  |  |  | |
| FLAME FAIL - PTFI | ● | ● | ● | ○ | ○ | ○ | Flame failure occurred during pilot trial for ignition. |
| FLAME FAIL - MTFI | ● | ● | ○ | ○ | ● | ○ | Flame failure occurred during main trial for ignition. |
| FLAME FAIL | ● | ○ | ● | ○ | ○ | ● | Flame failure occurred during main burner on period. |
| FALSE FLAME - PURGE ³ | ○ | ● | ● | ● | ● | ○ | Flame was sensed for more than 4 sec. during purge. |
| FALSE FLAME | ○ | ○ | ● | ○ | ● | ○ | Flame sensed by the burner for more than 60 seconds at the start of the burner cycle. |
| 3-P RUN INTLCK OPEN - PURGE | ● | ○ | ● | ○ | ● | ○ | Running interlock circuit (3-P) has opened during purge for 10 minutes (2 minutes for EPD382). |
| 3-P RUN INTLCK CLOSED ¹ | ○ | ● | ● | ○ | ● | ○ | Running interlock circuit (3-P) was closed for more than 1 minute at the start of the burner cycle. |
| M-D LOW FIRE START OPEN | ○ | ● | ○ | ○ | ● | ○ | The low fire start interlock has failed to close after 10 minutes during purge (2 minutes for EPD382). |
| 13-3 FUEL VALVE END SWITCH OPEN | ● | ○ | ● | ● | ● | ○ | The fuel valve end switch (13-3) has opened during startup or purge. |
| CHECK CHASSIS | ○ | ● | ● | ○ | ● | ● | Voltage on term. 7 at wrong time or defective chassis. ² |
| CHECK PROGRAMMER | ● | ● | ● | ○ | ● | ● | Voltage on terminals 5 or 6 at improper time or high electrical noise or defective programmer. ² |
| CHECK AMPLIFIER | ○ | ○ | ○ | ● | ● | ● | High electrical noise or defective amplifier ² |
| CHECK SCANNER | ○ | ○ | ● | ● | ○ | ○ | Flame sig. detected during shutter close time of 45UV5. |
| SCANNER NOISE | ● | ● | ○ | ● | ● | ● | Electrical noise due to ignition cable. |
| SHORT CIRCUIT TERM 5,6,7 | ○ | ○ | ○ | ○ | ● | ○ | Excessive current or short circuit on terminals 5, 6, or 7. |
| EXPANSION MODULE | ● | ○ | ○ | ● | ● | ● | Defective Coupler on E300 |
| AUTO CHECK FAIL | ○ | ● | ○ | ● | ● | ● | Diagnostic check of flame amplifier failed. |
| LINE FREQUENCY NOISE DETECTED | ○ | ● | ● | ○ | ○ | ○ | Electrical noise detected on terminals L1 and L2. |
| FUEL VALVE STATE CHANGE | ● | ● | ● | ○ | ○ | ● | During PTFI, Term. 7 is not the same as previous cycle. |

¹ 3-P Open to Start switch is enabled.

² Refer to Bulletin E-1101 for possible additional causes.

³ Engineering Code 1 only.

⁴ Older engineer codes require pushing the reset button twice.



TYPICAL WIRING ARRANGEMENT FOR PILOT IGNITED BURNERS USING EPD380, EPD381, EPD382, AND EPD390 PROGRAMMERS

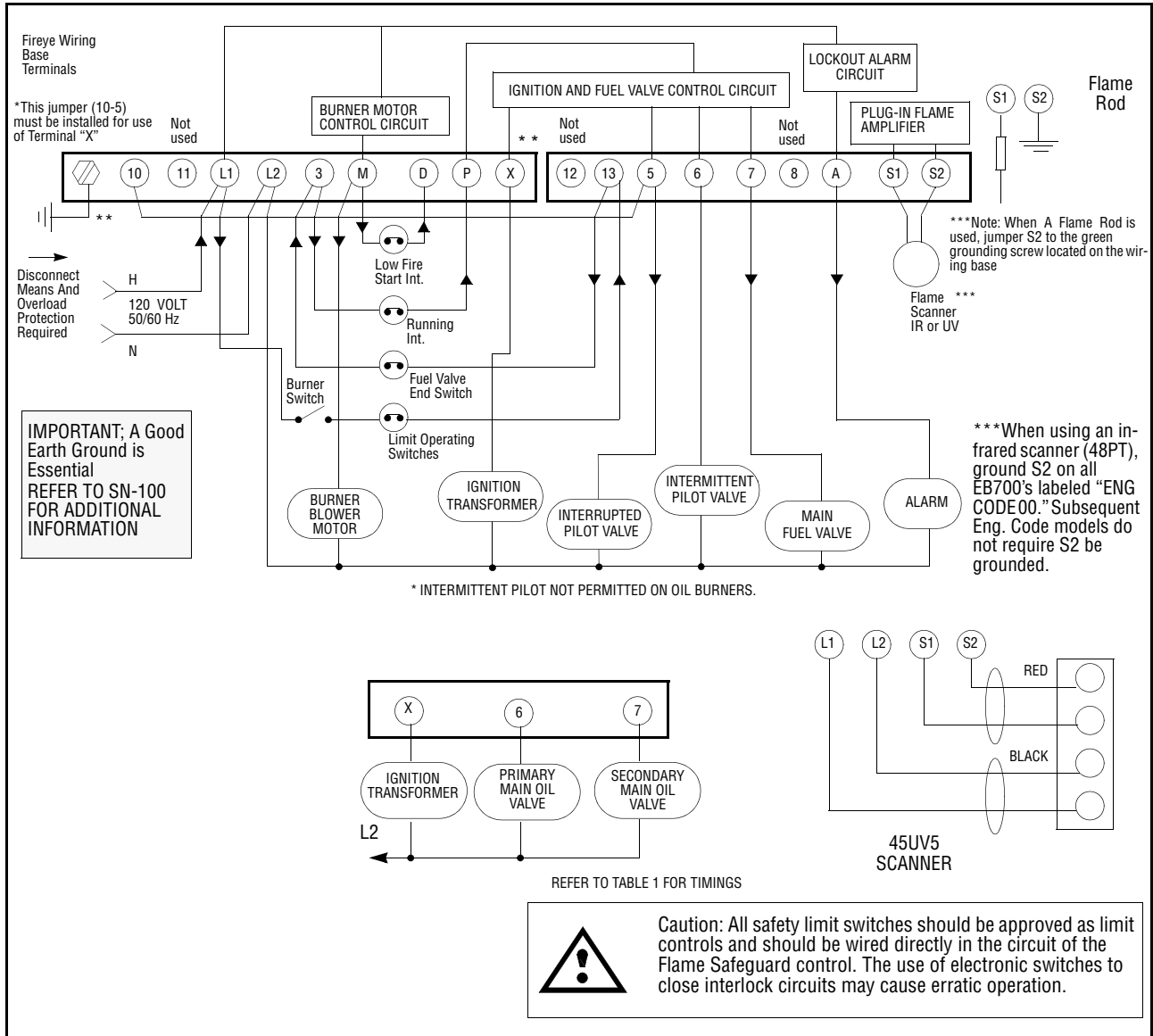

FLAME MONITOR ELECTRICAL NOISE

In applications which appear to have excessive electrical noise, it may be helpful to add an electrical noise suppressor to the power supply of the control circuit.

AUXILIARY DEVICE IN M-D-8 CIRCUIT AT FLAME MONITOR CONTROL

The function of the low fire start interlock circuit internally in a new Fireye Flame Monitor unit is accomplished by highly reliable solid state electronic circuitry. This prohibits the connection of power consuming devices (i.e. lamps, annunciators, relays, timers, etc.) to the D terminal.

COMBINATION FUEL BURNERS

NOTE: An important safety feature of the FLAME-MONITOR system is the ability to monitor proper timed operation of critical terminals. Jumpering of these terminals could therefore cause the control to sense an unusual condition and LOCK OUT.

When changing fuels through a gas/oil selector switch **and** the gas **pilot** is used for **both** fuels, wire the oil and gas main valve through one leg of selector switch as follows (See Page 9 for wiring terminals X, 5, and 6):

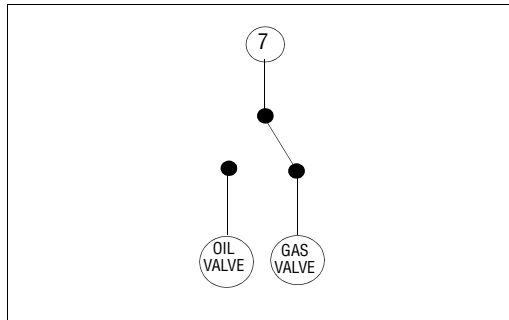

When changing fuels on combination oil and gas burners, if DIRECT SPARK IGNITION is used on oil and gas pilot is used on gas, wire as follows:

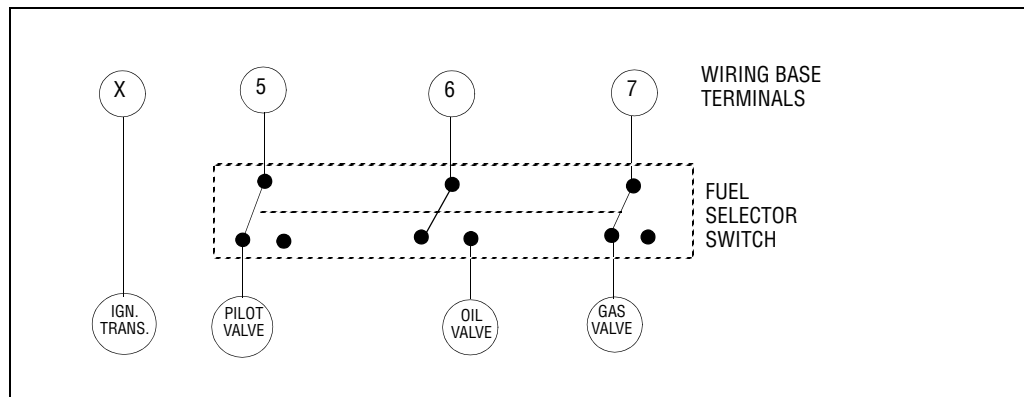

*As shown, ignition spark on for 5 seconds. Option for 10 second spark, wire to terminal 5





NOTICE

When Fireeye products are combined with equipment manufactured by others and/or integrated into systems designed or manufactured by others, the Fireeye warranty, as stated in its General Terms and Conditions of Sale, pertains only to the Fireeye products and not to any other equipment or to the combined system or its overall performance.

WARRANTIES

FIREYE guarantees for *one year from the date of installation or 18 months from date of manufacture* of its products to replace, or, at its option, to repair any product or part thereof (except lamps, electronic tubes and photocells) which is found defective in material or workmanship or which otherwise fails to conform to the description of the product on the face of its sales order. **THE FOREGOING IS IN LIEU OF ALL OTHER WARRANTIES AND FIREYE MAKES NO WARRANTY OF MERCHANTABILITY OR ANY OTHER WARRANTY, EXPRESS OR IMPLIED.** Except as specifically stated in these general terms and conditions of sale, remedies with respect to any product or part number manufactured or sold by Fireeye shall be limited exclusively to the right to replacement or repair as above provided. In no event shall Fireeye be liable for consequential or special damages of any nature that may arise in connection with such product or part.



FIREYE®
3 Manchester Road
Derry, New Hampshire 03038
www.fireeye.com

EPD-3801
AUGUST 6, 2007
Supersedes Sept. 32005



FIREYE® EPD380, EPD381, EPD382, EPD390 PROGRAMMER MODULES

AN ALTERNATIVE PROGRAMMER FOR USE
WITH THE FLAME-MONITOR™ SYSTEM



DESCRIPTION

The Fireye EPD380, EPD381, EPD382, and EPD390 Programmer Modules are used with the FLAME-MONITOR™ Burner Management Control System. The operational characteristics are determined by the selection of the programmer. These characteristics include timing functions, switching sequences, and LED display.

The EPD programmers incorporate a series of seven (7) LED indicator lights to annunciate the current operating status of the FLAME-MONITOR control, as well as the reason for the last lockout condition. The EPD programmers include an RJ45 style connector to interface with a remote alphanumeric display (P/N ED510) and two (2) RJ style connectors to connect to an E500 communication interface. The EPD FLAME-MONITOR System can be upgraded to include an E300 Expansion Module (remote alpha-numeric display required). The system also provides a 0-10 VDC test jack signal (located on the front bezel) to indicate flame signal strength.

The EPD380, EPD381, EPD382, and EPD390 provide start-up programming, safe-start check, and flame monitoring supervision. They insure proof of low fire position and fuel valve end switch safety checks. A running interlock circuit on the FLAME-MONITOR system constantly monitors the limit switches, air flow switches, and fuel pressure switches through the programmer. The control recycles if any of these circuits are open at the improper point in the control cycle. The EPD380, EPD381, EPD382, and EPD390 programmer modules also provide the option that requires the 3-P running interlock circuit to be proven open at the start of the operating cycle. This option is selected via a switch located on the bottom of the programmer module. (See “3-P Running Interlock Circuit - Proven Open To Start”). A modulator (firing rate motor) circuit is not provided on the EPD380, EPD381, EPD382, and EPD390 Programmer Modules.

The programmer module will de-energize all fuel valve circuits within four (4) seconds (max.) following a flame failure, or at the end of the pilot trial for ignition period if no flame is detected. An alarm circuit will be energized following a safety lockout.

The EPD programmer is the heart of the FLAME-MONITOR System and incorporates a plug-in design for easy installation. It is microprocessor based and stores the burner cycle and on-time history that is accessible with the ED510 alpha-numeric remote display, E500 Communication Interface or Modbus communications. If replaced, the new programmer card will begin accumulating a new history.

Refer to Bulletin E-1101 for detailed information on the FLAME-MONITOR System.



WARNING: While all controls are mechanically interchangeable because they mate with a common wiring base, you must select the correct model for your application. Inappropriate application of a control could result in an unsafe condition hazardous to life and property. Selection of a control for a particular application should be made by a competent professional, such as a Boiler/Burner Service technician licensed by a state or other government agency.

TIMING CHARTS

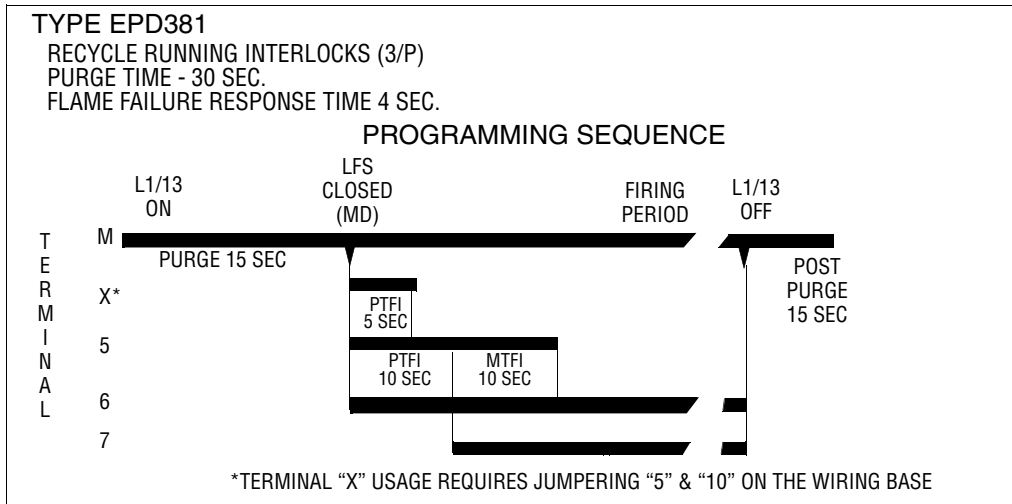
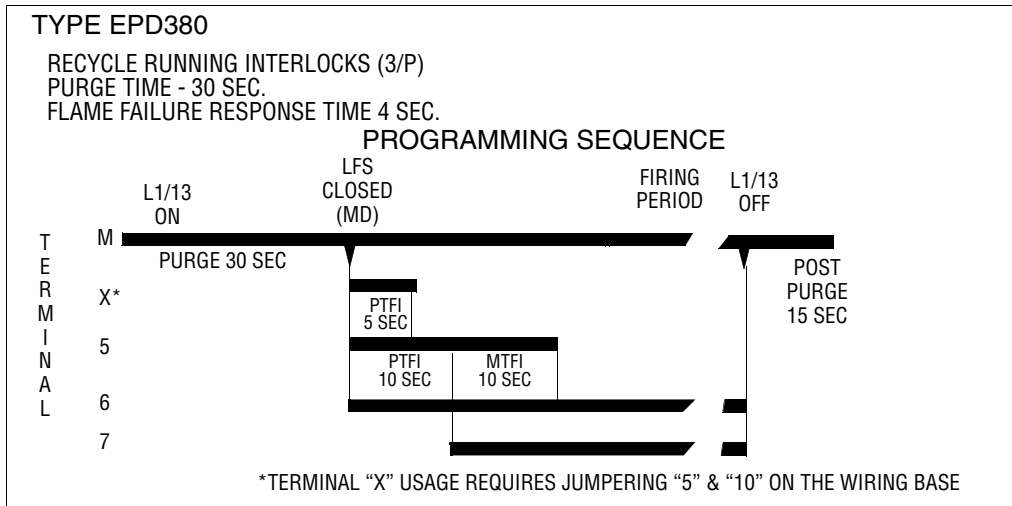

NOTE: All Programmings have a 2 second safe start check before initiating purge.

TYPE EPD382

RECYCLE RUNNING INTERLOCKS (3/P)
 PURGE TIME - 1 SEC.
 FLAME FAILURE RESPONSE TIME 4 SEC.

PROGRAMMING SEQUENCE

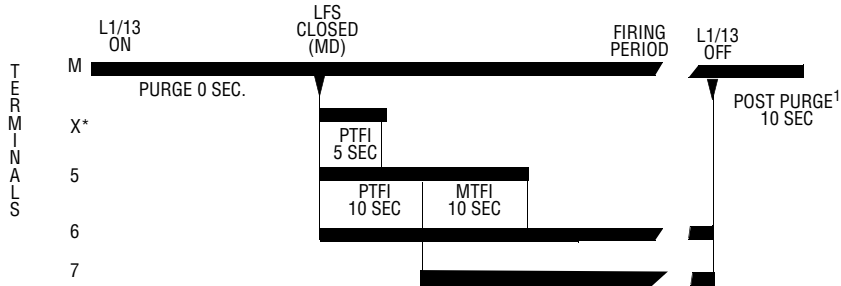

*TERMINAL "X" USAGE REQUIRES JUMPERING "5" & "10" ON THE WIRING BASE

TYPE EPD390

RECYCLE RUNNING INTERLOCKS (3/P)
 PURGE TIME - 90 SEC.
 FLAME FAILURE RESPONSE TIME 4 SEC.

PROGRAMMING SEQUENCE

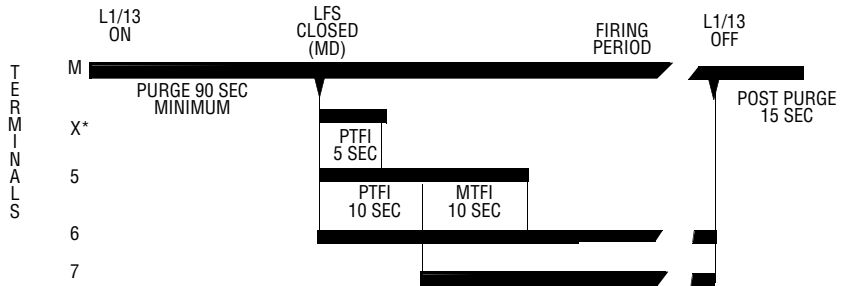

*TERMINAL "X" USAGE REQUIRES JUMPERING "5" & "10" ON THE WIRING BASE

NOTE: All Programmers have a 2 second safe start check before initiating purge.

¹Programmer provides 15 second post purge following a safety lockout.

TABLE 1.

| OPERATING TEMPERATURE LIMITS | | | | |
|--|--------------------|-------|---------|-------|
| CONTROL | MAXIMUM | | MINIMUM | |
| | E110, EB700, EB701 | 140°F | 60°C | -40°F |
| EP, EPD Programmers | 140°F | 60°C | -40°F | -40°C |
| All Amplifiers | 140°F | 60°C | -40°F | -40°C |
| ED510 Display | 140°F | 60°C | 32°F | 0°C |
| Scanner UV1A, UV2, UV8A, 45UV3 | 200°F | 93°C | -40°F | -40°C |
| 45UV5-1007, 45UV5-1009 55UV5-1007, 55UV5-1009 | 200°F | 93°C | -40°F | -40°C |
| Flame Rod (Tip 2460° F) | 1500°F | 816°C | -40°F | -40°C |
| 48PT2 | 125°F | 52°C | -40°F | -40°C |
| Humidity: 85% R.H. (Non-condensing) | | | | |

INSTALLATION

Remove power from its wiring base before proceeding. Remove the control from the wiring base. If the control is a E100 FLAME-MONITOR control, remove the alpha-numeric display (ED500) and Type EP programmer module (e.g.: EP160). If the control is a D-Series style control, replace the entire D-Series control (chassis, programmer, and amplifier) with the FLAME-MONITOR type control.

The EPD programmer modules are used with the Fireeye E110 base chassis. They are installed in the chassis by inserting the EPD programmer module into the second slot on the control. This slot is marked "Programmer Module" on the side of the chassis.

***NOTE:** The EPD programmer modules use two slot positions on the EB700 chassis ("Programmer Module" and "Display Module"). An ED510 alpha-numeric display can be added remote to the FLAME-MONITOR and EPD programmer.*

EPD programmer modules are designed to fit only in the proper slot. They cannot be snapped into place if inserted in the wrong location. **DO NOT FORCE THEM.**

An amplifier module and flame scanner are also required for the FLAME-MONITOR control.

Wiring Considerations for Remote Meter



CAUTION: When connecting a remote meter to the test jacks located on the front of the EPD programmer module, care should be taken to insure the remote meter wiring leads are at least twelve (12) inches away from any high ignition source (e.g.: cables for ignition transformer).

Failure to follow this recommendation could cause the control to lockout and display the message "lockout scanner noise" or cause the control to freeze up, requiring the interruption of power to the control to reset the condition.

ORDERING LED INDICATOR LIGHTS:

Table 2:

| EPD Programmer Module | | | | | | |
|-----------------------|---------------|---------|-----------------|---------|--------------|------------------|
| PART NO. | USED WITH | PURGE | IGNITION TIMING | | | FFRT |
| | | | | PTFI | MTFI | |
| EPD380 | EB700 E110 | 30 Sec. | Term X | 5 Sec. | | 4 Sec. (max.) |
| | | | Term 5 | 10 Sec. | 10 Sec. | |
| | | | Term 6 | 10 Sec. | Intermittent | |
| EPD381 | EB700 E110 | 15 Sec. | Term X | 5 Sec. | | 4 Sec. (max.) |
| | | | Term 5 | 10 Sec. | 10 Sec. | |
| | | | Term 6 | 10 Sec. | Intermittent | |
| EPD382 | EB700 E110 | 0 Sec. | Term X | 5 Sec. | | 4 Sec. (max.) |
| | | | Term 5 | 10 Sec. | 10 Sec. | |
| | | | Term 6 | 10 Sec. | Intermittent | |
| EPD390 | EB700 E110 | 90 Sec. | Term X | 5 Sec. | | 4 Sec. (max.) |
| | | | Term 5 | 10 Sec. | 10 Sec. | |
| | | | Term 6 | 10 Sec. | Intermittent | |







FFRT is the maximum Flame Failure Response Time
NOTE: All modules have a recycle running interlock circuit (3/P)

The EPD programmer modules have seven (7) LED indicator lights to annunciate the operating status of the control, as well as provide the reason for the last lockout condition. Each LED has a graphic symbol to describe its function (see Table 3).

| | |
|--------------|--|
| ALARM | In the event of a lockout condition, the Alarm LED will blink, the remaining LED's will light up to indicate the lockout condition. See "Safety Lockout Codes." |
| FAN | Lights when the blower motor is energized (terminal M) and flashes when the RUN/CHECK switch is in the "Check" position during purge, PTFI, and AUTO |
| OPEN DAMPER | This LED is only used to annunciate a lockout code. See Page 8. |
| CLOSE DAMPER | Will blink when the modulator motor is being driven to the low fire position (circuit 10-12 made). Once the low fire switch closes (M-D), this LED will light constant. This LED provides the status of the low fire start interlock circuit (M-D). This LED lights anytime the M-D circuit closes during pre-purge, PTFI, MTFI, post purge. |
| IGNITION | Will blink during Pilot Trial For Ignition (PTFI). Will light constant during Main Trial For Ignition (MTFI). |
| AUTO | Blinks when the RUN/CHECK switch is in the "Check" mode during the run period. |
| FLAME | Will light whenever flame is detected by the flame scanner. |

BLINKING LED'S: When the burner is off, the LED's will blink in succession every 60 seconds to indicate the off condition. Pressing the Reset button with the burner off will also blink the LED's in succession.

Table 3:

| | | | | | | |
|---|---|---|---|---|---|---|
| ALARM | FAN | OPEN DAMPER | CLOSE DAMPER | IGNITION | AUTO | FLAME |
|  |  |  |  |  |  |  |



OPERATION

Refer to the wiring suggestions shown on page 9 proceeding to power the FLAME-MONITOR control. Refer to Bulletin E-1101 for items such as scanner installation, short circuit tests and additional safety information.

Note that for direct spark ignited oil burners, substitute the words “main oil valve” for “pilot valve.”

Important: If a remote alpha-numeric display is also installed, the display will scroll a history message for 15 seconds on initial power-up and restarts following a power failure.

3-P RUNNING INTERLOCK CIRCUIT - PROVEN OPEN TO START:

The EPD380, EPD381, EPD382, and EPD390 programmer modules provide the option that requires the 3-P running interlock circuit to be proven open at the start of the operating cycle. If this option is enabled, the 3-P running interlock circuit **MUST be open** at the start of the operating cycle (L1- 13 circuit closed). If this option is enabled and the 3-P circuit is closed at the start of the operating cycle, the control will hold for one (1) minute waiting for the 3-P circuit to open. The blower motor (terminal M) will not be energized until the 3-P circuit opens. The “Fan” and “Auto” LEDs will blink until the 3-P circuit opens. If after one (1) minute, the 3-P circuit does not open, the control will lockout and display the lockout code for “3-P RUN INTERLOCK CLOSED.” This option is enabled or disabled via a switch located on the bottom of the programmer. The programmers are shipped with this option disabled.

SETUP OF DAMPER MOTOR LOW-FIRE END SWITCH

The “Close Damper” LED provides positive indication of the position of the damper motor low fire end switch during Purge, PTFI, MTFI, Post Purge, and when the “Check/Run” switch is in the “Check” position. This feature allows easy set-up and proper adjustment of the modulating motor low fire end switch.

START-UP (Normal Cycle):

1. Constant 120 VAC should be available to terminals L1 and L2 on the wiring base.
2. The operating control circuit (L1-13) will close, signaling the burner to start its firing sequence.
3. If the 3-P Open To Start switch is enabled, the 3-P circuit must be open before the cycle will continue. See (3-P RUNNING INTERLOCK CIRCUIT - PROVEN OPEN TO START).
4. Assuming the fuel valve end switch (13-3) is closed, the burner/blower motor (terminal M) circuit is energized. **The “Fan” LED will light.** The running interlock (limit) circuit (3-P) will close provided there is sufficient purge air available and all remaining interlocks are closed.
5. The EPD380 provides a 30 second purge, the EPD381 provides a 15 second purge, the EPD 382 provides a 1 second purge, and the EPD390 provides a 90 second purge. All pre-purge times are preceded by a 2 second safe start check.
6. When the pre-purge is completed, the control will wait for the low fire switch (M-D) to close. When the switch closes, **the “Close Damper” LED will light constant**, and the trial for ignition sequence will start. If the M-D circuit does not close, the program will hold in this position for ten (10) minutes waiting for the circuit to close. If it does not close, the control will lockout.
7. When the purge is completed and the low fire start switch (M-D) closes, the Pilot Trial for Ignition (PTFI) period begins with the terminals X*, 5 and 6 being energized simultaneously. **The “Ignition” LED will blink.** This period is ten (10) seconds in duration.

***NOTE:** Terminal X is only energized for 5 seconds during the PTFI period. If flame is detected during the 10 second PTFI period, the “Flame” LED will light, and the MTFI (Main Trail for Ignition) sequence will start. If no flame is detected after ten seconds, the control will de-energize terminals 5 and 6 and lockout.*

** **NOTE:** The use of terminal “X” as an ignition terminal requires placing a jumper between terminals “5” and “10” on the wiring base.*



- When flame is detected, the test meter jacks on the front of the EPD display will provide an indication of flame signal strength. A remote alpha-numeric display will also provide a readout of the flame signal strength.

TABLE 4.

| | Test Meter Jacks | Alpha-Numeric Display |
|--------------------|------------------|-----------------------|
| Minimum Acceptable | 3.0 VDC | 6-16 |
| Normal | 4.0-10.0 VDC | 20-80 |

- With flame proven at the end of PTFI, the main flame trial for ignition (MTFI) begins and terminal 7 is energized. The **“Ignition” LED will light constant**. Terminal 5 is de-energized ten (10) seconds later. Terminal 6 will remain energized during the entire firing period.
- At the end of MTFI period, the **“Ignition” LED goes out**. The test meter jacks and remote alpha-numeric display will provide an indication of flame signal strength.

NORMAL SHUTDOWN

- When the operating control circuit (L1-13) opens, the main fuel valve is de-energized and the **“Flame” LED goes out**.
NOTE: If any flame is still detected by the flame scanner, the “Flame” LED will remain lit.
- Following the post purge, the burner/blower motor is de-energized. The **“Fan” LED goes out**. The EPD380, EPD381, and EPD390 provide a 15 second post purge. The EPD382 provides a 10 second post purge.
- The burner is now off. The LED's shall blink in succession every 60 seconds to indicate the off condition. Pressing the Reset button with the burner off will also blink the LED's in succession.

SAFETY SHUTDOWN







In the event of a lockout condition, the **Alarm LED will light**. See “Resetting a Lockout” on page 8.

- If the low fire start switch (M-D) or running interlock circuit (3-P) have not closed after a ten (10) minute “Hold” period during prepurge, the control will lockout and the blower motor will be de-energized. If the interlock circuit opens during the trial for ignition period or firing period, all fuel valves will be de-energized, the control will initiate a 15 second post purge (10 second post purge for the EPD382), **and then recycle**. See above for condition of running interlock circuit during prepurge.
- If the 3-P Open To Start switch is enabled, and the 3-P circuit is closed at the start of the operating cycle, the control will hold for one (1) minute waiting for the 3-P circuit to open. If after one (1) minute, the 3-P circuit does not open, the control will lockout.
- If pilot flame is not detected during the 10 second trial for ignition period, the pilot valve and ignition transformer will be de-energized and the control will lockout.
- If main flame is not detected for a continuous four (4) second period during the main trial for ignition period, all fuel valves will be de-energized and the control will lockout.
- If the main flame fails during a firing cycle, all fuel valves will be de-energized within four (4) seconds (max.) after loss of flame signal and the control will lockout.
- If flame is seen at an improper time once the blower motor is energized (e.g.: during purge), the control will lockout within four seconds.
- If flame is detected while the operating control (L1-13) is open, the **“Flame” LED will light** and if the flame signal (real or simulated) is still present after sixty (60) seconds, the control will lockout.
- If the operating control (L1-13) closes and flame is still detected, the control will not energize the blower motor but will wait for the flame signal to go away. If after sixty (60) seconds, the flame signal is still present, the control will lockout. If the flame signal goes away within 60 seconds after the operating control closes, the control will energize the blower motor and proceed with a normal start-up.

RESETTING A LOCKOUT⁴

In the event of a lockout condition, the Reset button must be pressed and released to reset the lockout. When a lockout occurs, only the Alarm LED is initially lit and blinks while the remaining LED's indicate the cause of lockout.

NOTE: The Reset button must be pressed and released for the control to recognize the button.

| LOCKOUT MESSAGE | LED DISPLAY READOUT ● = ON | | | | | | DESCRIPTION |
|------------------------------------|---|---|---|---|---|--|---|
| | FAN | OPEN DAMPER | CLOSE DAMPER | IGNITION | AUTO | FLAME | |
| |  |  |  |  |  |  | |
| FLAME FAIL - PTFI | ● | ● | ● | ○ | ○ | ○ | Flame failure occurred during pilot trial for ignition. |
| FLAME FAIL - MTFI | ● | ● | ○ | ○ | ● | ○ | Flame failure occurred during main trial for ignition. |
| FLAME FAIL | ● | ○ | ● | ○ | ○ | ● | Flame failure occurred during main burner on period. |
| FALSE FLAME - PURGE ³ | ○ | ● | ● | ● | ● | ○ | Flame was sensed for more than 4 sec. during purge. |
| FALSE FLAME | ○ | ○ | ● | ○ | ● | ○ | Flame sensed by the burner for more than 60 seconds at the start of the burner cycle. |
| 3-P RUN INTLCK OPEN - PURGE | ● | ○ | ● | ○ | ● | ○ | Running interlock circuit (3-P) has opened during purge for 10 minutes (2 minutes for EPD382). |
| 3-P RUN INTLCK CLOSED ¹ | ○ | ● | ● | ○ | ● | ○ | Running interlock circuit (3-P) was closed for more than 1 minute at the start of the burner cycle. |
| M-D LOW FIRE START OPEN | ○ | ● | ○ | ○ | ● | ○ | The low fire start interlock has failed to close after 10 minutes during purge (2 minutes for EPD382). |
| 13-3 FUEL VALVE END SWITCH OPEN | ● | ○ | ● | ● | ● | ○ | The fuel valve end switch (13-3) has opened during startup or purge. |
| CHECK CHASSIS | ○ | ● | ● | ○ | ● | ● | Voltage on term. 7 at wrong time or defective chassis. ² |
| CHECK PROGRAMMER | ● | ● | ● | ○ | ● | ● | Voltage on terminals 5 or 6 at improper time or high electrical noise or defective programmer. ² |
| CHECK AMPLIFIER | ○ | ○ | ○ | ● | ● | ● | High electrical noise or defective amplifier ² |
| CHECK SCANNER | ○ | ○ | ● | ● | ○ | ○ | Flame sig. detected during shutter close time of 45UV5. |
| SCANNER NOISE | ● | ● | ○ | ● | ● | ● | Electrical noise due to ignition cable. |
| SHORT CIRCUIT TERM 5,6,7 | ○ | ○ | ○ | ○ | ● | ○ | Excessive current or short circuit on terminals 5, 6, or 7. |
| EXPANSION MODULE | ● | ○ | ○ | ● | ● | ● | Defective Coupler on E300 |
| AUTO CHECK FAIL | ○ | ● | ○ | ● | ● | ● | Diagnostic check of flame amplifier failed. |
| LINE FREQUENCY NOISE DETECTED | ○ | ● | ● | ○ | ○ | ○ | Electrical noise detected on terminals L1 and L2. |
| FUEL VALVE STATE CHANGE | ● | ● | ● | ○ | ○ | ● | During PTFI, Term. 7 is not the same as previous cycle. |

¹ 3-P Open to Start switch is enabled.

² Refer to Bulletin E-1101 for possible additional causes.

³ Engineering Code 1 only.

⁴ Older engineer codes require pushing the reset button twice.



TYPICAL WIRING ARRANGEMENT FOR PILOT IGNITED BURNERS USING EPD380, EPD381, EPD382, AND EPD390 PROGRAMMERS

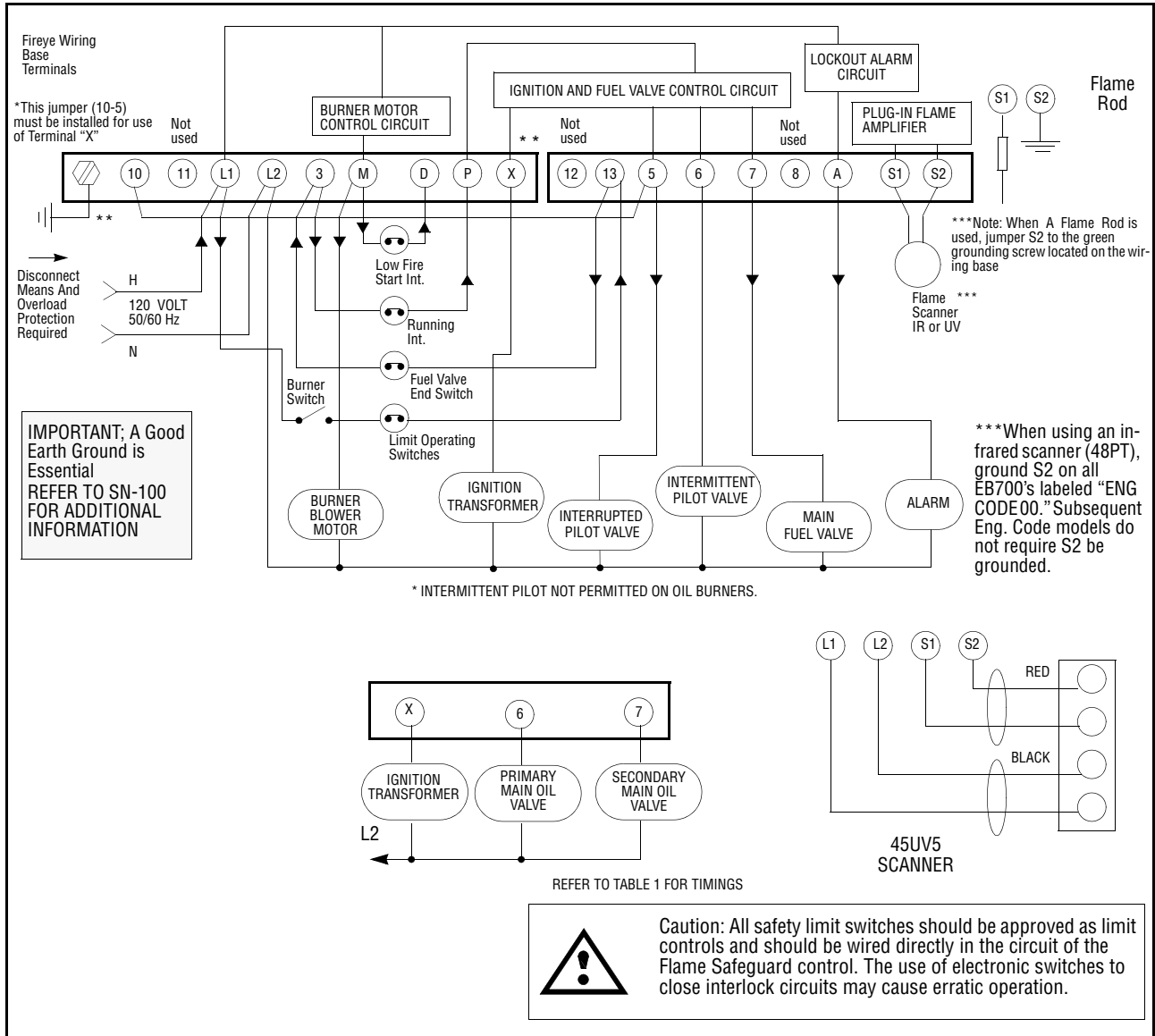

FLAME MONITOR ELECTRICAL NOISE

In applications which appear to have excessive electrical noise, it may be helpful to add an electrical noise suppressor to the power supply of the control circuit.

AUXILIARY DEVICE IN M-D-8 CIRCUIT AT FLAME MONITOR CONTROL

The function of the low fire start interlock circuit internally in a new Fireye Flame Monitor unit is accomplished by highly reliable solid state electronic circuitry. This prohibits the connection of power consuming devices (i.e. lamps, annunciators, relays, timers, etc.) to the D terminal.

COMBINATION FUEL BURNERS

NOTE: An important safety feature of the FLAME-MONITOR system is the ability to monitor proper timed operation of critical terminals. Jumpering of these terminals could therefore cause the control to sense an unusual condition and LOCK OUT.

When changing fuels through a gas/oil selector switch **and** the gas **pilot** is used for **both** fuels, wire the oil and gas main valve through one leg of selector switch as follows (See Page 9 for wiring terminals X, 5, and 6):

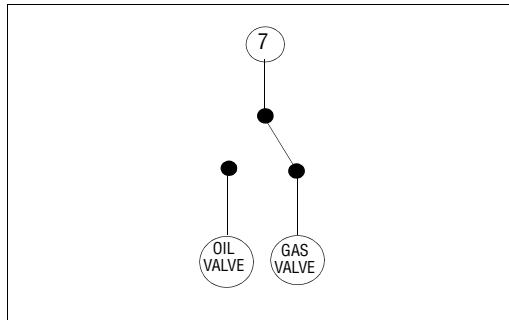

When changing fuels on combination oil and gas burners, if DIRECT SPARK IGNITION is used on oil and gas pilot is used on gas, wire as follows:

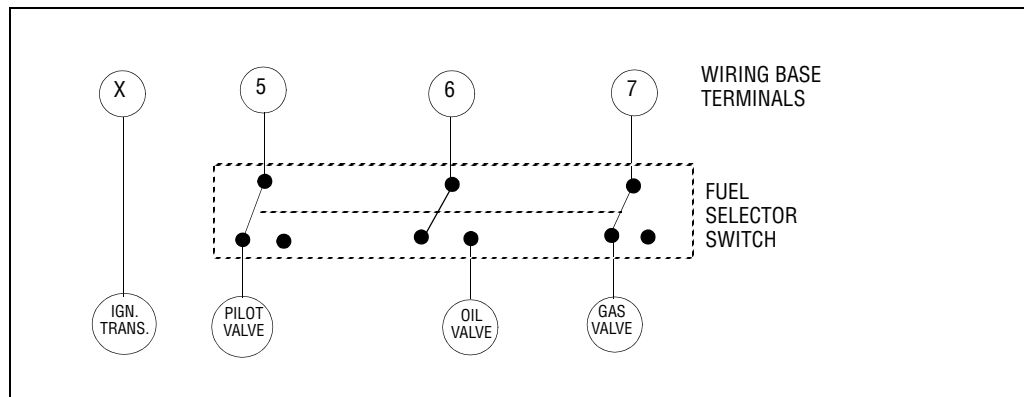

*As shown, ignition spark on for 5 seconds. Option for 10 second spark, wire to terminal 5



NOTICE

When Fireeye products are combined with equipment manufactured by others and/or integrated into systems designed or manufactured by others, the Fireeye warranty, as stated in its General Terms and Conditions of Sale, pertains only to the Fireeye products and not to any other equipment or to the combined system or its overall performance.

WARRANTIES

FIREYE guarantees for *one year from the date of installation or 18 months from date of manufacture* of its products to replace, or, at its option, to repair any product or part thereof (except lamps, electronic tubes and photocells) which is found defective in material or workmanship or which otherwise fails to conform to the description of the product on the face of its sales order. **THE FOREGOING IS IN LIEU OF ALL OTHER WARRANTIES AND FIREYE MAKES NO WARRANTY OF MERCHANTABILITY OR ANY OTHER WARRANTY, EXPRESS OR IMPLIED.** Except as specifically stated in these general terms and conditions of sale, remedies with respect to any product or part number manufactured or sold by Fireeye shall be limited exclusively to the right to replacement or repair as above provided. In no event shall Fireeye be liable for consequential or special damages of any nature that may arise in connection with such product or part.



FIREYE®
3 Manchester Road
Derry, New Hampshire 03038
www.fireeye.com

EPD-3801
AUGUST 6, 2007
Supersedes Sept. 32005

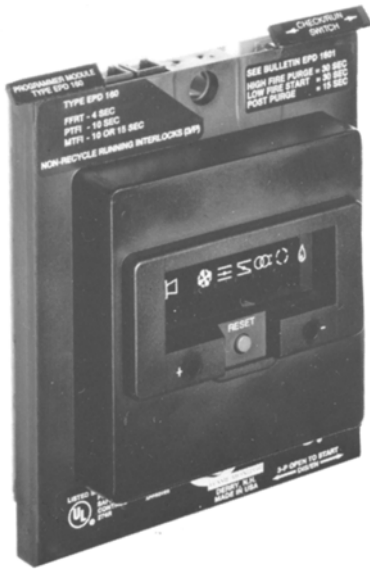

FIREYE® EPD380, EPD381, EPD382, EPD390 PROGRAMMER MODULES

AN ALTERNATIVE PROGRAMMER FOR USE
WITH THE FLAME-MONITOR™ SYSTEM



DESCRIPTION

The Fireye EPD380, EPD381, EPD382, and EPD390 Programmer Modules are used with the FLAME-MONITOR™ Burner Management Control System. The operational characteristics are determined by the selection of the programmer. These characteristics include timing functions, switching sequences, and LED display.

The EPD programmers incorporate a series of seven (7) LED indicator lights to annunciate the current operating status of the FLAME-MONITOR control, as well as the reason for the last lockout condition. The EPD programmers include an RJ45 style connector to interface with a remote alphanumeric display (P/N ED510) and two (2) RJ style connectors to connect to an E500 communication interface. The EPD FLAME-MONITOR System can be upgraded to include an E300 Expansion Module (remote alpha-numeric display required). The system also provides a 0-10 VDC test jack signal (located on the front bezel) to indicate flame signal strength.

The EPD380, EPD381, EPD382, and EPD390 provide start-up programming, safe-start check, and flame monitoring supervision. They insure proof of low fire position and fuel valve end switch safety checks. A running interlock circuit on the FLAME-MONITOR system constantly monitors the limit switches, air flow switches, and fuel pressure switches through the programmer. The control recycles if any of these circuits are open at the improper point in the control cycle. The EPD380, EPD381, EPD382, and EPD390 programmer modules also provide the option that requires the 3-P running interlock circuit to be proven open at the start of the operating cycle. This option is selected via a switch located on the bottom of the programmer module. (See “3-P Running Interlock Circuit - Proven Open To Start”). A modulator (firing rate motor) circuit is not provided on the EPD380, EPD381, EPD382, and EPD390 Programmer Modules.

The programmer module will de-energize all fuel valve circuits within four (4) seconds (max.) following a flame failure, or at the end of the pilot trial for ignition period if no flame is detected. An alarm circuit will be energized following a safety lockout.

The EPD programmer is the heart of the FLAME-MONITOR System and incorporates a plug-in design for easy installation. It is microprocessor based and stores the burner cycle and on-time history that is accessible with the ED510 alpha-numeric remote display, E500 Communication Interface or Modbus communications. If replaced, the new programmer card will begin accumulating a new history.

Refer to Bulletin E-1101 for detailed information on the FLAME-MONITOR System.



WARNING: While all controls are mechanically interchangeable because they mate with a common wiring base, you must select the correct model for your application. Inappropriate application of a control could result in an unsafe condition hazardous to life and property. Selection of a control for a particular application should be made by a competent professional, such as a Boiler/Burner Service technician licensed by a state or other government agency.

TIMING CHARTS

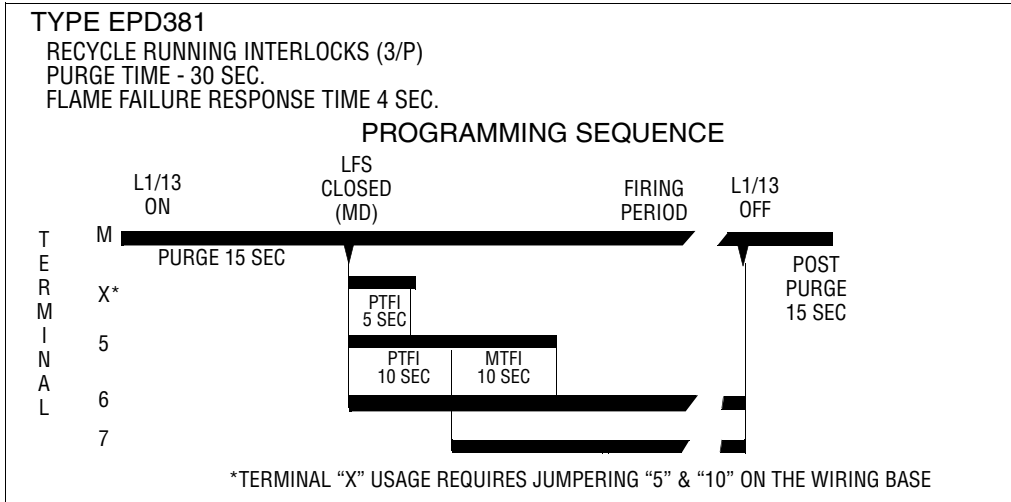
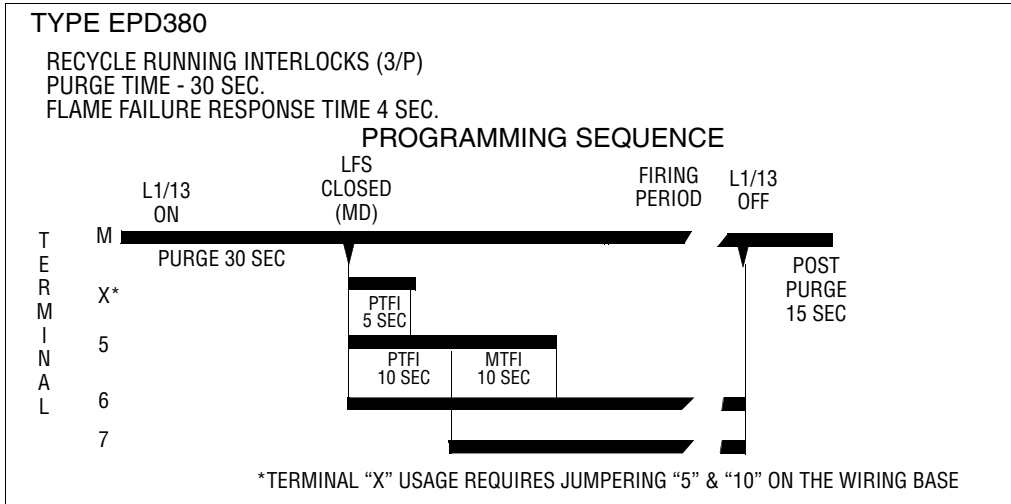

NOTE: All Programmings have a 2 second safe start check before initiating purge.

TYPE EPD382

RECYCLE RUNNING INTERLOCKS (3/P)
 PURGE TIME - 1 SEC.
 FLAME FAILURE RESPONSE TIME 4 SEC.

PROGRAMMING SEQUENCE

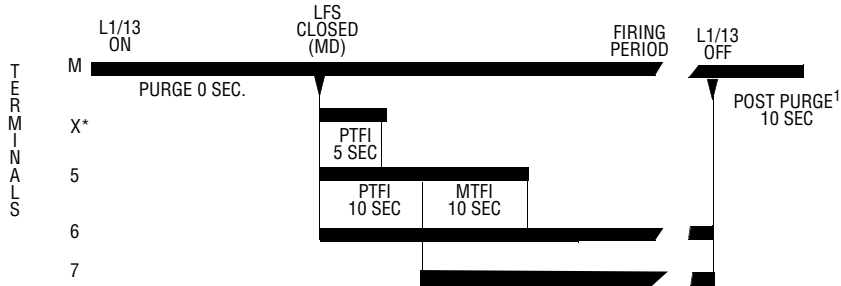

*TERMINAL "X" USAGE REQUIRES JUMPERING "5" & "10" ON THE WIRING BASE

TYPE EPD390

RECYCLE RUNNING INTERLOCKS (3/P)
 PURGE TIME - 90 SEC.
 FLAME FAILURE RESPONSE TIME 4 SEC.

PROGRAMMING SEQUENCE

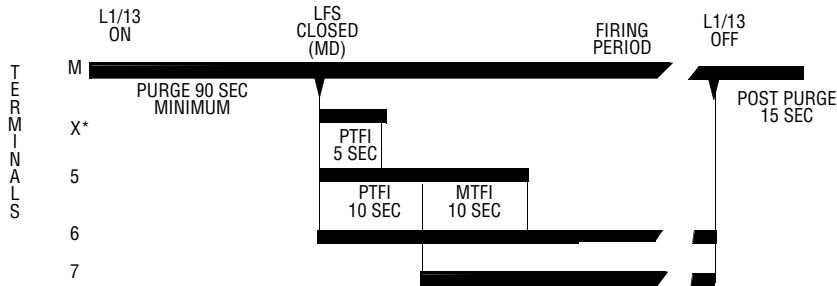

*TERMINAL "X" USAGE REQUIRES JUMPERING "5" & "10" ON THE WIRING BASE

NOTE: All Programmers have a 2 second safe start check before initiating purge.

¹ Programmer provides 15 second post purge following a safety lockout.

TABLE 1.

| OPERATING TEMPERATURE LIMITS | | | | |
|--|--------------------|-------|---------|-------|
| CONTROL | MAXIMUM | | MINIMUM | |
| | E110, EB700, EB701 | 140°F | 60°C | -40°F |
| EP, EPD Programmers | 140°F | 60°C | -40°F | -40°C |
| All Amplifiers | 140°F | 60°C | -40°F | -40°C |
| ED510 Display | 140°F | 60°C | 32°F | 0°C |
| Scanner UV1A, UV2, UV8A, 45UV3 | 200°F | 93°C | -40°F | -40°C |
| 45UV5-1007, 45UV5-1009 55UV5-1007, 55UV5-1009 | 200°F | 93°C | -40°F | -40°C |
| Flame Rod (Tip 2460° F) | 1500°F | 816°C | -40°F | -40°C |
| 48PT2 | 125°F | 52°C | -40°F | -40°C |
| Humidity: 85% R.H. (Non-condensing) | | | | |

INSTALLATION

Remove power from its wiring base before proceeding. Remove the control from the wiring base. If the control is a E100 FLAME-MONITOR control, remove the alpha-numeric display (ED500) and Type EP programmer module (e.g.: EP160). If the control is a D-Series style control, replace the entire D-Series control (chassis, programmer, and amplifier) with the FLAME-MONITOR type control.

The EPD programmer modules are used with the Fireeye E110 base chassis. They are installed in the chassis by inserting the EPD programmer module into the second slot on the control. This slot is marked "Programmer Module" on the side of the chassis.

***NOTE:** The EPD programmer modules use two slot positions on the EB700 chassis ("Programmer Module" and "Display Module"). An ED510 alpha-numeric display can be added remote to the FLAME-MONITOR and EPD programmer.*

EPD programmer modules are designed to fit only in the proper slot. They cannot be snapped into place if inserted in the wrong location. **DO NOT FORCE THEM.**

An amplifier module and flame scanner are also required for the FLAME-MONITOR control.

Wiring Considerations for Remote Meter



CAUTION: When connecting a remote meter to the test jacks located on the front of the EPD programmer module, care should be taken to insure the remote meter wiring leads are at least twelve (12) inches away from any high ignition source (e.g.: cables for ignition transformer).

Failure to follow this recommendation could cause the control to lockout and display the message "lockout scanner noise" or cause the control to freeze up, requiring the interruption of power to the control to reset the condition.

ORDERING LED INDICATOR LIGHTS:

Table 2:

| EPD Programmer Module | | | | | | |
|-----------------------|---------------|---------|-----------------|---------|--------------|------------------|
| PART NO. | USED WITH | PURGE | IGNITION TIMING | | | FFRT |
| | | | | PTFI | MTFI | |
| EPD380 | EB700 E110 | 30 Sec. | Term X | 5 Sec. | | 4 Sec. (max.) |
| | | | Term 5 | 10 Sec. | 10 Sec. | |
| | | | Term 6 | 10 Sec. | Intermittent | |
| EPD381 | EB700 E110 | 15 Sec. | Term X | 5 Sec. | | 4 Sec. (max.) |
| | | | Term 5 | 10 Sec. | 10 Sec. | |
| | | | Term 6 | 10 Sec. | Intermittent | |
| EPD382 | EB700 E110 | 0 Sec. | Term X | 5 Sec. | | 4 Sec. (max.) |
| | | | Term 5 | 10 Sec. | 10 Sec. | |
| | | | Term 6 | 10 Sec. | Intermittent | |
| EPD390 | EB700 E110 | 90 Sec. | Term X | 5 Sec. | | 4 Sec. (max.) |
| | | | Term 5 | 10 Sec. | 10 Sec. | |
| | | | Term 6 | 10 Sec. | Intermittent | |







FFRT is the maximum Flame Failure Response Time
NOTE: All modules have a recycle running interlock circuit (3/P)

The EPD programmer modules have seven (7) LED indicator lights to annunciate the operating status of the control, as well as provide the reason for the last lockout condition. Each LED has a graphic symbol to describe its function (see Table 3).

| | |
|--------------|--|
| ALARM | In the event of a lockout condition, the Alarm LED will blink, the remaining LED's will light up to indicate the lockout condition. See "Safety Lockout Codes." |
| FAN | Lights when the blower motor is energized (terminal M) and flashes when the RUN/CHECK switch is in the "Check" position during purge, PTFI, and AUTO |
| OPEN DAMPER | This LED is only used to annunciate a lockout code. See Page 8. |
| CLOSE DAMPER | Will blink when the modulator motor is being driven to the low fire position (circuit 10-12 made). Once the low fire switch closes (M-D), this LED will light constant. This LED provides the status of the low fire start interlock circuit (M-D). This LED lights anytime the M-D circuit closes during pre-purge, PTFI, MTFI, post purge. |
| IGNITION | Will blink during Pilot Trial For Ignition (PTFI). Will light constant during Main Trial For Ignition (MTFI). |
| AUTO | Blinks when the RUN/CHECK switch is in the "Check" mode during the run period. |
| FLAME | Will light whenever flame is detected by the flame scanner. |

BLINKING LED'S: When the burner is off, the LED's will blink in succession every 60 seconds to indicate the off condition. Pressing the Reset button with the burner off will also blink the LED's in succession.

Table 3:

| | | | | | | |
|---|---|---|---|---|---|---|
| ALARM | FAN | OPEN DAMPER | CLOSE DAMPER | IGNITION | AUTO | FLAME |
|  |  |  |  |  |  |  |



OPERATION

Refer to the wiring suggestions shown on page 9 proceeding to power the FLAME-MONITOR control. Refer to Bulletin E-1101 for items such as scanner installation, short circuit tests and additional safety information.

Note that for direct spark ignited oil burners, substitute the words “main oil valve” for “pilot valve.”

Important: If a remote alpha-numeric display is also installed, the display will scroll a history message for 15 seconds on initial power-up and restarts following a power failure.

3-P RUNNING INTERLOCK CIRCUIT - PROVEN OPEN TO START:

The EPD380, EPD381, EPD382, and EPD390 programmer modules provide the option that requires the 3-P running interlock circuit to be proven open at the start of the operating cycle. If this option is enabled, the 3-P running interlock circuit **MUST be open** at the start of the operating cycle (L1- 13 circuit closed). If this option is enabled and the 3-P circuit is closed at the start of the operating cycle, the control will hold for one (1) minute waiting for the 3-P circuit to open. The blower motor (terminal M) will not be energized until the 3-P circuit opens. The “Fan” and “Auto” LEDs will blink until the 3-P circuit opens. If after one (1) minute, the 3-P circuit does not open, the control will lockout and display the lockout code for “3-P RUN INTERLOCK CLOSED.” This option is enabled or disabled via a switch located on the bottom of the programmer. The programmers are shipped with this option disabled.

SETUP OF DAMPER MOTOR LOW-FIRE END SWITCH

The “Close Damper” LED provides positive indication of the position of the damper motor low fire end switch during Purge, PTFI, MTFI, Post Purge, and when the “Check/Run” switch is in the “Check” position. This feature allows easy set-up and proper adjustment of the modulating motor low fire end switch.

START-UP (Normal Cycle):

1. Constant 120 VAC should be available to terminals L1 and L2 on the wiring base.
2. The operating control circuit (L1-13) will close, signaling the burner to start its firing sequence.
3. If the 3-P Open To Start switch is enabled, the 3-P circuit must be open before the cycle will continue. See (3-P RUNNING INTERLOCK CIRCUIT - PROVEN OPEN TO START).
4. Assuming the fuel valve end switch (13-3) is closed, the burner/blower motor (terminal M) circuit is energized. **The “Fan” LED will light.** The running interlock (limit) circuit (3-P) will close provided there is sufficient purge air available and all remaining interlocks are closed.
5. The EPD380 provides a 30 second purge, the EPD381 provides a 15 second purge, the EPD 382 provides a 1 second purge, and the EPD390 provides a 90 second purge. All pre-purge times are preceded by a 2 second safe start check.
6. When the pre-purge is completed, the control will wait for the low fire switch (M-D) to close. When the switch closes, **the “Close Damper” LED will light constant**, and the trial for ignition sequence will start. If the M-D circuit does not close, the program will hold in this position for ten (10) minutes waiting for the circuit to close. If it does not close, the control will lockout.
7. When the purge is completed and the low fire start switch (M-D) closes, the Pilot Trial for Ignition (PTFI) period begins with the terminals X*, 5 and 6 being energized simultaneously. **The “Ignition” LED will blink.** This period is ten (10) seconds in duration.

***NOTE:** Terminal X is only energized for 5 seconds during the PTFI period. If flame is detected during the 10 second PTFI period, the “Flame” LED will light, and the MTFI (Main Trail for Ignition) sequence will start. If no flame is detected after ten seconds, the control will de-energize terminals 5 and 6 and lockout.*

** **NOTE:** The use of terminal “X” as an ignition terminal requires placing a jumper between terminals “5” and “10” on the wiring base.*



- When flame is detected, the test meter jacks on the front of the EPD display will provide an indication of flame signal strength. A remote alpha-numeric display will also provide a readout of the flame signal strength.

TABLE 4.

| | Test Meter Jacks | Alpha-Numeric Display |
|--------------------|------------------|-----------------------|
| Minimum Acceptable | 3.0 VDC | 6-16 |
| Normal | 4.0-10.0 VDC | 20-80 |

- With flame proven at the end of PTFI, the main flame trial for ignition (MTFI) begins and terminal 7 is energized. The **“Ignition” LED will light constant**. Terminal 5 is de-energized ten (10) seconds later. Terminal 6 will remain energized during the entire firing period.
- At the end of MTFI period, the **“Ignition” LED goes out**. The test meter jacks and remote alpha-numeric display will provide an indication of flame signal strength.

NORMAL SHUTDOWN

- When the operating control circuit (L1-13) opens, the main fuel valve is de-energized and the **“Flame” LED goes out**.
NOTE: If any flame is still detected by the flame scanner, the “Flame” LED will remain lit.
- Following the post purge, the burner/blower motor is de-energized. The **“Fan” LED goes out**. The EPD380, EPD381, and EPD390 provide a 15 second post purge. The EPD382 provides a 10 second post purge.
- The burner is now off. The LED's shall blink in succession every 60 seconds to indicate the off condition. Pressing the Reset button with the burner off will also blink the LED's in succession.

SAFETY SHUTDOWN

In the event of a lockout condition, the **Alarm LED will light**. See “Resetting a Lockout” on page 8.







- If the low fire start switch (M-D) or running interlock circuit (3-P) have not closed after a ten (10) minute “Hold” period during prepurge, the control will lockout and the blower motor will be de-energized. If the interlock circuit opens during the trial for ignition period or firing period, all fuel valves will be de-energized, the control will initiate a 15 second post purge (10 second post purge for the EPD382), **and then recycle**. See above for condition of running interlock circuit during prepurge.
- If the 3-P Open To Start switch is enabled, and the 3-P circuit is closed at the start of the operating cycle, the control will hold for one (1) minute waiting for the 3-P circuit to open. If after one (1) minute, the 3-P circuit does not open, the control will lockout.
- If pilot flame is not detected during the 10 second trial for ignition period, the pilot valve and ignition transformer will be de-energized and the control will lockout.
- If main flame is not detected for a continuous four (4) second period during the main trial for ignition period, all fuel valves will be de-energized and the control will lockout.
- If the main flame fails during a firing cycle, all fuel valves will be de-energized within four (4) seconds (max.) after loss of flame signal and the control will lockout.
- If flame is seen at an improper time once the blower motor is energized (e.g.: during purge), the control will lockout within four seconds.
- If flame is detected while the operating control (L1-13) is open, the **“Flame” LED will light** and if the flame signal (real or simulated) is still present after sixty (60) seconds, the control will lockout.
- If the operating control (L1-13) closes and flame is still detected, the control will not energize the blower motor but will wait for the flame signal to go away. If after sixty (60) seconds, the flame signal is still present, the control will lockout. If the flame signal goes away within 60 seconds after the operating control closes, the control will energize the blower motor and proceed with a normal start-up.



RESETTING A LOCKOUT⁴

In the event of a lockout condition, the Reset button must be pressed and released to reset the lockout. When a lockout occurs, only the Alarm LED is initially lit and blinks while the remaining LED's indicate the cause of lockout.

NOTE: The Reset button must be pressed and released for the control to recognize the button.

| LOCKOUT MESSAGE | LED DISPLAY READOUT ● = ON | | | | | | DESCRIPTION |
|------------------------------------|---|---|---|---|---|--|---|
| | FAN | OPEN DAMPER | CLOSE DAMPER | IGNITION | AUTO | FLAME | |
| |  |  |  |  |  |  | |
| FLAME FAIL - PTFI | ● | ● | ● | ○ | ○ | ○ | Flame failure occurred during pilot trial for ignition. |
| FLAME FAIL - MTFI | ● | ● | ○ | ○ | ● | ○ | Flame failure occurred during main trial for ignition. |
| FLAME FAIL | ● | ○ | ● | ○ | ○ | ● | Flame failure occurred during main burner on period. |
| FALSE FLAME - PURGE ³ | ○ | ● | ● | ● | ● | ○ | Flame was sensed for more than 4 sec. during purge. |
| FALSE FLAME | ○ | ○ | ● | ○ | ● | ○ | Flame sensed by the burner for more than 60 seconds at the start of the burner cycle. |
| 3-P RUN INTLCK OPEN - PURGE | ● | ○ | ● | ○ | ● | ○ | Running interlock circuit (3-P) has opened during purge for 10 minutes (2 minutes for EPD382). |
| 3-P RUN INTLCK CLOSED ¹ | ○ | ● | ● | ○ | ● | ○ | Running interlock circuit (3-P) was closed for more than 1 minute at the start of the burner cycle. |
| M-D LOW FIRE START OPEN | ○ | ● | ○ | ○ | ● | ○ | The low fire start interlock has failed to close after 10 minutes during purge (2 minutes for EPD382). |
| 13-3 FUEL VALVE END SWITCH OPEN | ● | ○ | ● | ● | ● | ○ | The fuel valve end switch (13-3) has opened during startup or purge. |
| CHECK CHASSIS | ○ | ● | ● | ○ | ● | ● | Voltage on term. 7 at wrong time or defective chassis. ² |
| CHECK PROGRAMMER | ● | ● | ● | ○ | ● | ● | Voltage on terminals 5 or 6 at improper time or high electrical noise or defective programmer. ² |
| CHECK AMPLIFIER | ○ | ○ | ○ | ● | ● | ● | High electrical noise or defective amplifier ² |
| CHECK SCANNER | ○ | ○ | ● | ● | ○ | ○ | Flame sig. detected during shutter close time of 45UV5. |
| SCANNER NOISE | ● | ● | ○ | ● | ● | ● | Electrical noise due to ignition cable. |
| SHORT CIRCUIT TERM 5,6,7 | ○ | ○ | ○ | ○ | ● | ○ | Excessive current or short circuit on terminals 5, 6, or 7. |
| EXPANSION MODULE | ● | ○ | ○ | ● | ● | ● | Defective Coupler on E300 |
| AUTO CHECK FAIL | ○ | ● | ○ | ● | ● | ● | Diagnostic check of flame amplifier failed. |
| LINE FREQUENCY NOISE DETECTED | ○ | ● | ● | ○ | ○ | ○ | Electrical noise detected on terminals L1 and L2. |
| FUEL VALVE STATE CHANGE | ● | ● | ● | ○ | ○ | ● | During PTFI, Term. 7 is not the same as previous cycle. |

¹ 3-P Open to Start switch is enabled.

² Refer to Bulletin E-1101 for possible additional causes.

³ Engineering Code 1 only.

⁴ Older engineer codes require pushing the reset button twice.



TYPICAL WIRING ARRANGEMENT FOR PILOT IGNITED BURNERS USING EPD380, EPD381, EPD382, AND EPD390 PROGRAMMERS

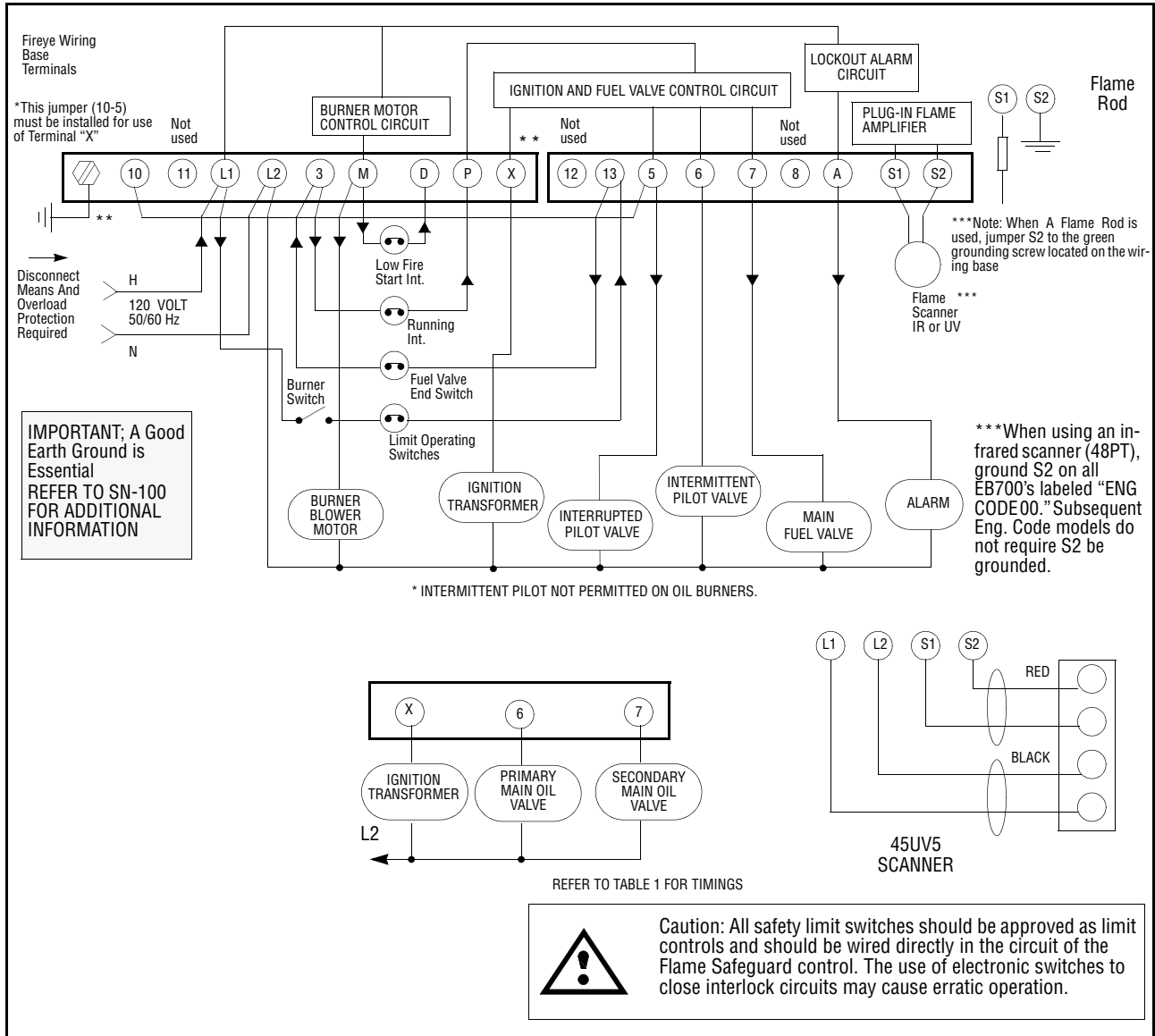

FLAME MONITOR ELECTRICAL NOISE

In applications which appear to have excessive electrical noise, it may be helpful to add an electrical noise suppressor to the power supply of the control circuit.

AUXILIARY DEVICE IN M-D-8 CIRCUIT AT FLAME MONITOR CONTROL

The function of the low fire start interlock circuit internally in a new Fireye Flame Monitor unit is accomplished by highly reliable solid state electronic circuitry. This prohibits the connection of power consuming devices (i.e. lamps, annunciators, relays, timers, etc.) to the D terminal.

COMBINATION FUEL BURNERS

NOTE: An important safety feature of the FLAME-MONITOR system is the ability to monitor proper timed operation of critical terminals. Jumpering of these terminals could therefore cause the control to sense an unusual condition and LOCK OUT.

When changing fuels through a gas/oil selector switch **and** the gas **pilot** is used for **both** fuels, wire the oil and gas main valve through one leg of selector switch as follows (See Page 9 for wiring terminals X, 5, and 6):

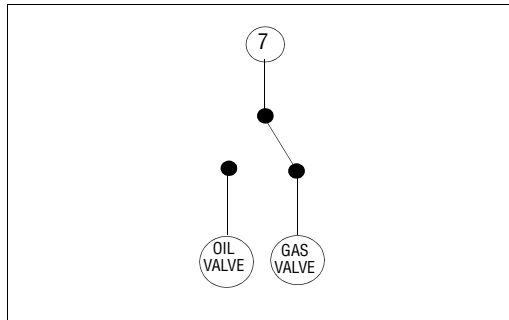

When changing fuels on combination oil and gas burners, if DIRECT SPARK IGNITION is used on oil and gas pilot is used on gas, wire as follows:

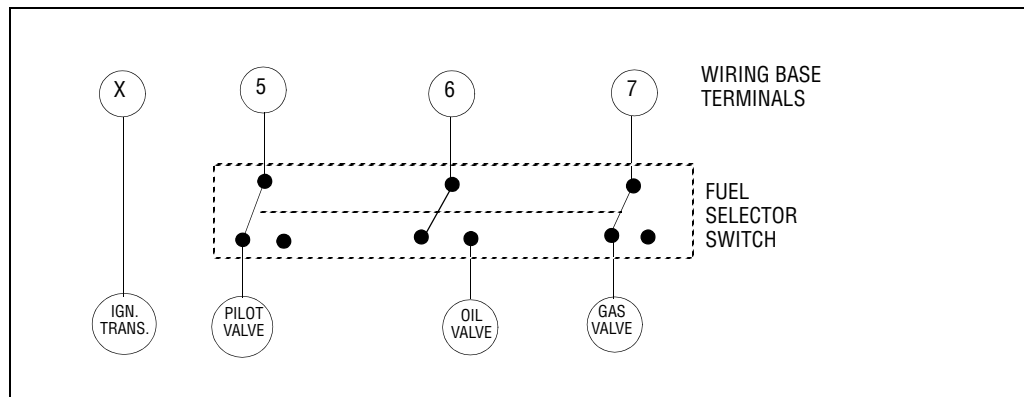

*As shown, ignition spark on for 5 seconds. Option for 10 second spark, wire to terminal 5



NOTICE

When Fireeye products are combined with equipment manufactured by others and/or integrated into systems designed or manufactured by others, the Fireeye warranty, as stated in its General Terms and Conditions of Sale, pertains only to the Fireeye products and not to any other equipment or to the combined system or its overall performance.

WARRANTIES

FIREYE guarantees for *one year from the date of installation or 18 months from date of manufacture* of its products to replace, or, at its option, to repair any product or part thereof (except lamps, electronic tubes and photocells) which is found defective in material or workmanship or which otherwise fails to conform to the description of the product on the face of its sales order. **THE FOREGOING IS IN LIEU OF ALL OTHER WARRANTIES AND FIREYE MAKES NO WARRANTY OF MERCHANTABILITY OR ANY OTHER WARRANTY, EXPRESS OR IMPLIED.** Except as specifically stated in these general terms and conditions of sale, remedies with respect to any product or part number manufactured or sold by Fireeye shall be limited exclusively to the right to replacement or repair as above provided. In no event shall Fireeye be liable for consequential or special damages of any nature that may arise in connection with such product or part.



FIREYE®
3 Manchester Road
Derry, New Hampshire 03038
www.fireeye.com

EPD-3801
AUGUST 6, 2007
Supersedes Sept. 32005