



FIREYE E210/211 FLAME-MONITOR™

**Microprocessor-Based
Burner Management Control
with
Message Center and
Self-Diagnostics**

DESCRIPTION

The FIREYE® FLAME-MONITOR™ control is a microprocessor based burner management control with self-diagnostics, non-volatile memory and a library of informational messages. These messages scroll out on the ED510 Display Module, providing operator status and failure mode information. The system provides the proper burner sequencing and monitoring of the flame on automatic burners, single or dual fuel fired burners, direct spark or pilot ignited burners and on/off or modulating burners. Inputs for all burner interlocks are provided: i.e. recycling limit and operating controls, non-recycling running interlocks, purge air flow switch and firing rate motor end switches. The FLAME-MONITOR control programs the burner/blower motor, ignition transformer, pilot and main valve for proper and safe burner operation to meet specifications of approval authorities.

On a safety shutdown, the ED510 message center will advise the operator that the control is in “ALARM” and scroll a message indicating the cause. Interchangeable flame amplifier and programmer modules allow for complete versatility in the selection of flame detectors and display language (English, French, Dutch, German, Spanish or Swedish).

Several operational characteristics of the EP113 programmer modules (with Engineering code 21 or later) are determined by six dipswitches located on the side of the programmer. These characteristics include non-recycle or recycle operation (3-P circuit), interrupted or intermittent operation of terminal 5, extended purge timing, and the option to enable or disable the requirement that the 3-P running interlock circuit is proven open at the start of the operating cycle.

Additional accessories include an expansion module. The E320 expansion module for the FIREYE FLAME-MONITOR control adds the capability of individually displaying any malfunction for an additional sixteen interlock switches. The module provides first-out annunciation of all interlocks.

Remote reset — see Bulletin E-8002

Expansion Module — see Bulletin E-3201



APPLICATION

- For single or dual fired burners, pilot ignited or direct ignited continuous duty.
- One basic model meets various European standards.
- ED510 message center indicating in English, French, Dutch, Spanish, or German program sequence and reasons for alarm burner shutdown
- A constant flame signal read-out via ED510 message center.
- Read-out of main fuel operation hours, burner cycles, total number of safety shutdowns, and the reason for the last six safety shutdowns via the ED510 message center.
- A run/check switch which allows the operator to stop the program sequence in any of three different positions (Purge, PTFI, or Auto).
- Selectable purge timings
- Different detection methods for the Flame-Monitor control are:
 - infrared
 - ultra-violet
 - ultra-violet self-check
 - flame rectificationwith a correspondingly large choice of flame scanner constructions.

DESIGN FEATURES

- Microprocessor based technology.
- Plug-in control unit with “snap-on” protection cover.
- “Burnt-in” electronic circuits eliminating aging and temperature problems.
- Gold-plated plug-in contact fingers
- Accurate timings; watchdog timer to supervise ignition and travel time of modulator motor
- Overload and short-circuit protection
- Built-in self-diagnostic

SPECIFICATIONS

Operating temperature limits:		
CHASSIS	TEMPERATURE	
	Max.	Min.
EB720	60°C	- 20°C *
EB721	60°C	- 20°C *
Amplifiers, Programmer	60°C	- 20°C *
ED510 Message Center	60°C	0°C *
All UV scanners	100°C	- 20°C *
All infrared scanners	52°C	- 20°C *

* Unit tested down to -20 °C. Minimum operating characteristics, subject to supply voltage changes

Humidity: 85% RH maximum (non-condensing).
All components epoxy coating sealed.



Supply voltage and electrical ratings

Supply Voltage:

EB720	220V (Europe) (min. 187V., max. 242V.) 240V (U.K.) (min. 204V. max. 264V.)
EB721	110V (min. 94V. max. 132V.)

Frequency: 50/60Hz

Power consumption: Operating: 25 VA
Standby: 13 VA

Typical timings – Timing chart

Prepurge time: 1 sec., 15 sec., 30 sec., 60 sec., 2 min., 5 min., 10 min., 15 min., (selectable by dipswitch on program module).
Factory set at 30 seconds.

Pilot ignition time (terminal X): 5 s

Pilot proving time (terminals 5 & 6): 10 s

Main flame ignition time:

Gas-pilot valve (terminal 5): 3s (intermittent operation selectable via dipswitch #2)

Oil-pilot valve (terminal 6): 5s

Post-purge: 10 s (becomes 20 s in case of flame or ignition failure)

Flame failure response time: Maximum 1 s for EP113

Note: Flame failure response time for the EP113 is 1.5 seconds when used with the ERT1 amplifier.

IP Rating: 00 **CAUTION:** FLAME-MONITOR control must be installed in a suitable electrical cabinet to ensure proper safety against electrical hazards.

20 Order dust cover Part Number EC603 to upgrade IP rating to 20.

LOAD RATINGS

TERMINAL	LOAD	MAX.
5-6	Pilot valve	250VA
X	Ignition transformer	360VA
7	Main valve	250VA
M	Blower motor or contactor	250VA
A	Alarm device	50VA
10-11 10-12 10-13	Modulator	125VA
Maximum simultaneous connected load 2000 VA The maximum wiring distance from the terminals to their connected loads shall not exceed 164 feet (50 meters).		



FLAME-MONITOR Ordering Information

E210 OR E211 FLAME-MONITOR (ONE REQUIRED)

E210 CONSISTS OF:

EB720 CHASSIS
EC600 DUST COVER
48-1836 MOUNTING SCREW

E211 CONSISTS OF:

EB721
EC600
48-1836

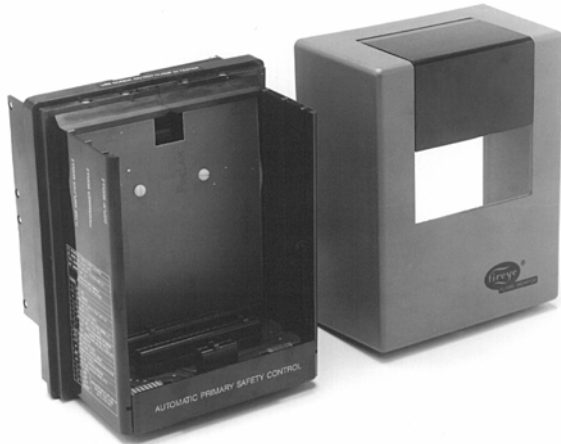

ED510 DISPLAY MODULE
ONE REQUIRED



AMPLIFIER MODULE (ONE REQUIRED)

E1R3
EUV1
EUVS4
ERT1



WIRING BASE (ONE REQUIRED)

60-1386-2
SURFACE MOUNT
(SHOWN)

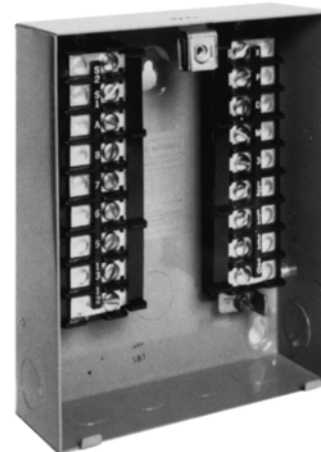

60-1466-2
CABINET MOUNT

PROGRAMMER MODULE (ONE REQUIRED)

EP PROGRAMMER

EP113E (ENGLISH)
EP113D (GERMAN)
EP113F (FRENCH)
EP113NL (DUTCH)
EP113ES (SPANISH)
EP113SW (SWEDISH)
EP113NR (ENGLISH fixed, non-recycle)

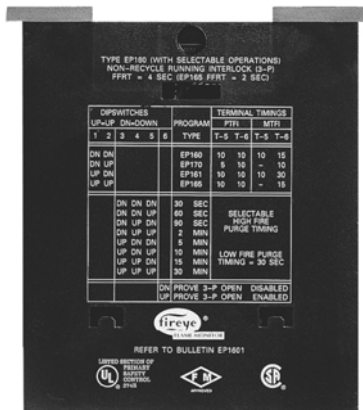



APPROVALS

CE: E210, E211, EP113D, EP113E, EP113F, EP113NL, EP113NR, EUV1, EUVS4, EIR3

Gas Appliances

Gas Appliance Directive: 90/396/EEC

Low Voltage Directive: 73/23/EEC

EMC Directive: 89/336/EEC

GASTEC: CG-63AP2200
(EN298, October 1993; EN230, November 1990)

Classification: F/I or T/L or C/L/J/B

Apave: E210, EP113F, EUV1, EUVS4, EIR3

FLAME SCANNERS

INFRARED			
Type	Cable Length	Version	Mounting
48PT2-1003	2400 mm	Straight head	1/2" NPT
48PT2-1007	1200 mm	Straight head	1/2" NPT
48PT2-9003	2400 mm	90° head	1/2" NPT
48PT2-9007	1200 mm	90° head	1/2" NPT
ULTRA-VIOLET			
Type	Cable Length	Mounting	
UV1A3	900 mm	1/2" NPT	
UV1A6	1800 mm	1/2" NPT	
UV2	900 mm	3/8" NPT	
45UV3-1050	2400 mm	for 3/4" pipe	
UV8A	1800 mm	1/2" 90° head	
ULTRA-VIOLET SELF-CHECK			
Type	Cable Length	Mounting	Voltage
45UV5-1007	1800 mm	1" BSP	230 V
45UV5-1008	1800 mm	1" BSP	110 V
45UV5-1009	1800 mm	1" NPT	120 V

ACCESSORIES AND SPARE PARTS

DESCRIPTION	TYPE	FOR
Firetron cell	4-263-1	48PT2
UV tube	4-314	45UV3, 45UV5
Lens	61-436	48PT2
Quartz lens (3/4")	46-56	45UV3
Quartz lens (1")	46-38	45UV5
Union coupling		
- with glass lens	60-801	48PT2
- with quartz glass	60-1257	UV1A
- with quartz lens	60-1290	UV1A
Heat insulator (1/2" NPT)	35-69	48PT2/UV1A
Heat insulator (1" BSP)	35-127-3	45UV5
Heat insulator (1" NPT)	35-127-1	45UV5
Swivel mount (1/2" NPT)	60-302	48PT2/UV1A
Swivel mount (1" BSP)	60-1664-4	45UV5
Swivel mount (1" NPT)	60-1664-3	45UV5

DIPSWITCHES FOR SELECTABLE OPERATION

Several operational characteristics of the EP113 programmer modules are determined by six (6) dipswitches located on the side of the programmer. These characteristics include non-recycle/recycle operation when the running interlock circuit (3-P) is opened (Dipswitch #1), interrupted or intermittent operation of terminal 5 (Dipswitch #2), extended purge timing (Dipswitches #3, #4, #5), and enable or disable the option that requires the 3-P running interlock circuit to be proven open at the start of the operating cycle (Dipswitch #6).



WARNING: THE INAPPROPRIATE SELECTION OR APPLICATION OF A PROGRAMMER MODULE COULD RESULT IN AN UNSAFE CONDITION HAZARDOUS TO LIFE AND PROPERTY. Changing the dipswitches modifies the operation of each programmer module. Care should be taken to insure the proper dipswitch settings. Setting the dipswitches for a particular application should be made by a competent professional, such as a Boiler/Burner technician licensed by a state or other government agency, engineering personnel of the burner, boiler, or furnace manufacturer (OEM) or in performance of duties based on information from the OEM.

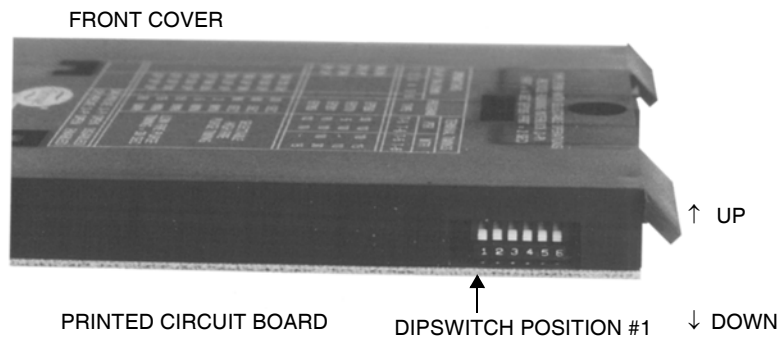



DIPSWITCH #1 - NON-RECYCLE OR RECYCLE OPERATION:

Dipswitch #1 determines if the control will lockout (dipswitch 1 is Down) or recycle (dipswitch 1 is Up) when the running interlock circuit (3-P) is opened during the firing cycle or **following a flame failure** after the control has released to modulation (following completion of MTFI). * The programmer is shipped with the switch down (non-recycle operation). See below for an overview of all dipswitch settings.

DIPSWITCH #1 IS PERMANENTLY DISABLED IN THE EP113NR									
DIPSWITCH POSITION									
U = UP		DN = DOWN				TERM	PTFI	MTFI	SEE DIPSWITCH #2
15	2	3	4	5	6				
Dn						X	5	—	
Up						5	15	3	
						6	15	3	
	Dn								Non Recycle on 3-P Open or Flame Fail
	Up								Recycle on 3-P Open or Flame Fail
	Dn								Interrupted
	Up								Intermittent
		Dn	Dn	Dn					30 SEC.
		Dn	Dn	Up					1 SEC.
		Dn	Up	Dn					15 SEC.
		Dn	Up	Up					60 SEC.
		Up	Dn	Dn					2 MIN.
		Up	Dn	Up					5 MIN.
		Up	Up	Dn					10 MIN.
		Up	Up	Up					15 MIN.
					Dn				Prove 3-P Open at start
					Up				Prove 3-P Open at start
									ENABLED
									DISABLED

DIPSWITCH #2 - INTERRUPTED OR INTERMITTENT OPERATION:

Dipswitch #2 selects either interrupted or intermittent operation of terminal 5. When terminal 5 is selected for interrupted operation (Dipswitch #2 is Down), terminal 5 is energized during pilot ignition (5 seconds), pilot proving (10 seconds), and MTFI (3 seconds) before de-energizing. When terminal 5 is selected for intermittent operation (Dipswitch #2 is Up), terminal 5 remains energized throughout the firing period. The programmer is shipped with the switch down (interrupted operation). See above for an overview of all Dipswitch settings.

DIPSWITCHES #3, 4, & 5 - PURGE TIMING

Dipswitches #3, 4, & 5 determine the purge timing for the programmer module. Purge timings are selectable from 1 second to 15 minutes. The purge timing is not initiated until the firing rate motor is driven to the high fire position (10-13 made) and the high fire switch is proven closed (term D-8). At the end of the purge timing, the firing rate motor is driven to the low fire position (10-12), and waits until the low fire start interlock is proven closed (M-D). Refer to the table on dipswitch functions to select the various purge timing.

DIPSWITCH #6 - 3-P RUNNING INTERLOCK CIRCUIT PROVEN OPEN TO START

Dipswitch #6 enables or disables the option that requires the 3-P running interlock circuit to be proven open at the start of the operating cycle. If this option is enabled (Dipswitch #6 is Down), the 3-P running interlock circuit is required to be open at the start of the operating cycle (L1- 3 circuit closed). If this option is disabled and the 3-P circuit is closed at the start of the operating cycle, the control will hold for 30 seconds waiting for the 3-P circuit to open. If after 30 seconds, the 3-P cir-

* The control will always initiate a safety lockout if the control fails to prove the presence of flame during PTFI or MTFI.

cuit does not open, the control will lockout. The programmers are shipped with this option enabled (switch 6 is in Down position).

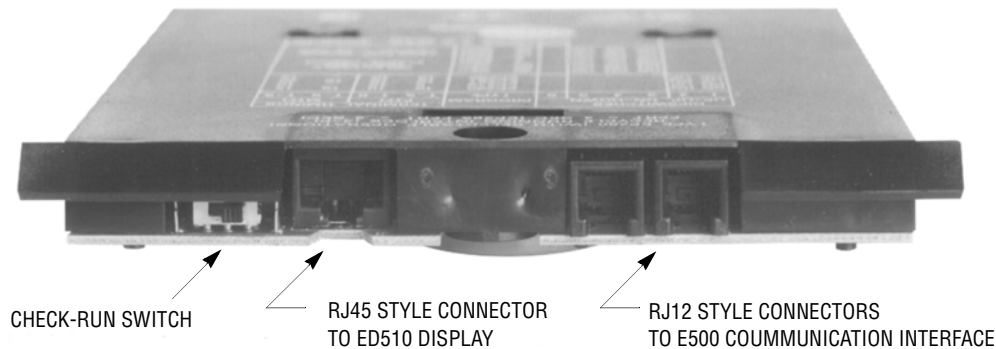

PROGRAMMER AND DISPLAY MODULE COMPATIBILITY

Two display modules are available for the FLAME-MONITOR control system (P/N's ED500* and ED510). The ED500* is an 8 character LED display that physically mounts in the card rack of the EB720/EB721 chassis. The ED510 is a 2 line by 16 character LCD with keypad to provide both current and historical information pertaining to the operation of the control. The ED510 display physically mounts onto the front cover of the programmer module (Engineering code 21 or later). Refer to Bulletin ED5101 for a complete description of the features and capabilities of the ED510 display module. Programmers with an Engineering code of 21 or later (e.g. 9514-21) are compatible with both the ED510 and ED500* display module. Programmers with an Engineering code before 21 are only compatible with the ED500 display.

RJ STYLE CONNECTORS

Programmer modules (with Engineering code 21 or later) include an RJ45 style connector to connect to the ED510 display module. The ED510 snaps onto the front cover of the programmer module. The ED580 cable (provided with ED510 Display) then plugs into the RJ45 style connectors on both the ED510 display and programmer module.

Check-Run Switch

The Check-Run switch is located on the top of the EP113 Programmer Module (Engineering code 21 or higher) and can be used to stop the control in its firing sequence at any time except MTFI. If moved during the MTFI period, it is not functional and automatic programming continues. It aids in the set-up and adjustment of the burner linkages, pilot assembly, etc.

E500 Communication Interface

EP113 Programmer modules (with Engineering code 21 or higher) include two (2) RJ12 style connectors to connect to the RS485 Interface on the E500 Communication Interface in a multi-drop wiring configuration with other devices. Refer to Bulletin E-5001. Up to six (6) each of EP programmers can be wired in a multi-drop configuration. (Unit address 00 to 15). When connected in this manner to the E500, a unit address must be set on each programmer module connected to the RS485 interface. (See Unit Address). Programmers can also be connected to the E500 via the standard flat ribbon cables (ED550).

UNIT ADDRESS

There are two methods to program the unit address when the EP113 programmer module is connected to the E500 via the RS485 interface:

Method One

1. Press the SCRL key until the screen displays PROGRAM SETUP

* ED500 is Obsolete



2. Press the MODE key and the screen displays PROGRAMMER EP113
3. Press the SCRL key until the screen displays UNIT ADDRESS #00 (or appropriate address).
4. Every time the RESET key is held down for 1 second and then released will increase the address by one.
5. Maximum address is 15. Then the address will roll over to 00.

Method Two

1. Make sure the control is not in a lockout condition. If so, pressing the reset button will reset the lockout condition and then proceed.
2. Open the operating control (term L1-3).
3. Move the "Check-Run" switch to the Check position.
4. The display will indicate Unit Address 00 (or the current address).
5. Every time the reset button is held down for 1 second and then released will increase the address by one.
6. Maximum address is 15. Then the address will roll over to 00.

OPERATION

The Fireye Flame-Monitor control provides proper burner sequencing and flame monitoring on automatic burners. It also provides the operator a status readout as well as diagnostic information. It has a number of unique messages which are simple to understand and interpret. These messages are, at option, in English, French, Dutch, Spanish or German.

Description of Interlocks

1. The opening of any interlock in the L1-3 circuit will stop the burner without causing lockout or alarm. When the interlocks are closed, the burner start sequence is initiated. These interlocks include the thermostat switch, which is closed when heat is required.
2. Running interlocks (3-P): If any interlock switch in this circuit opens, all open fuel valves will be closed immediately and the control will go in alarm or lockout (non-recycle operation). The control must then be manually reset. These interlocks include for instance the air flow switch.

Note: Dipswitch #1 on the EP113 programmer provides the option to recycle the control instead of going into alarm. See "Dipswitches for Selectable Operation."

3. High fire or purge interlock (D-8):. This is the firing rate motor linkage position switch or a differential air pressure switch that proves a maximum purge air flow rate.
4. Low fire start interlock (M-D): This is the firing rate motor linkage position switch or a damper position switch, which will prove both the linkage and damper are in their proper positions to begin burner light off.

START-UP PROGRAM

The E210/211 with ED510 display module, programmer module, flame amplifier module, and the appropriate flame detector, provides the following burner operation sequence.

1. With power applied the blower motor is energized through terminal M when the following conditions are met:
 - Recycling limits (demand for heat) are closed.
 - The air flow switch is open at start or opens within 30 sec. *
 - No lockout

The air flow switch closes. The other running interlocks (depending on fuel selection) also close (all within 30 sec.).

2. The firing rate motor is driven to the high fire position.

* Dipswitch #6 enables or disables this requirement, See "Dipswitches for Selectable Operation"

3. The prepurge is initiated when the high fire interlock (purge air flow interlock) is closed within 180 seconds, confirming that the firing rate motor reached its high fire position. The supervised prepurge time is 30 seconds.*
4. When the prepurge is completed, the firing rate motor is driven towards the low-fire position, to be reached within 180 seconds.
5. The burner is ready for ignition if the following conditions are met:
 - Recycling and non recycling interlocks closed.
 - Low-fire switch (minimum air flow switch) closed.
6. The spark ignition and the pilot valve are energized.
7. The ignition transformer is de-energized after 5 seconds pilot trial for ignition time

FLAME SIGNAL	COMMENT
0 — 9	Not acceptable
10	Minimum required
20 or more	Normal

8. As soon as flame is detected, the ED510 message center will provide a readout of the signal strength both during pilot proving time and main burner operation.
9. Following a 10 second proved pilot stabilization period, the main fuel valve (terminal 7) is energized.
10. After the main burner trial for ignition time (3 seconds for gas, 5 seconds for oil), the pilot valve is de-energized and the firing rate motor is released to automatic control.
11. The supervised start-up program has ended and the burner is in operation.

NORMAL BURNER SHUTDOWN

- When the operating control (recycling interlock) opens, the main fuel valve is de-energized and the firing rate motor is driven to the low position.
- Following a 10 second post-purge the blower motor is de-energized.

* Dipswitches #3, #4, and #5 extend the purge timing from 1 second up to 15 minutes. See “Dipswitches for Selectable Operation.”



SEQUENCE FLOW CHART

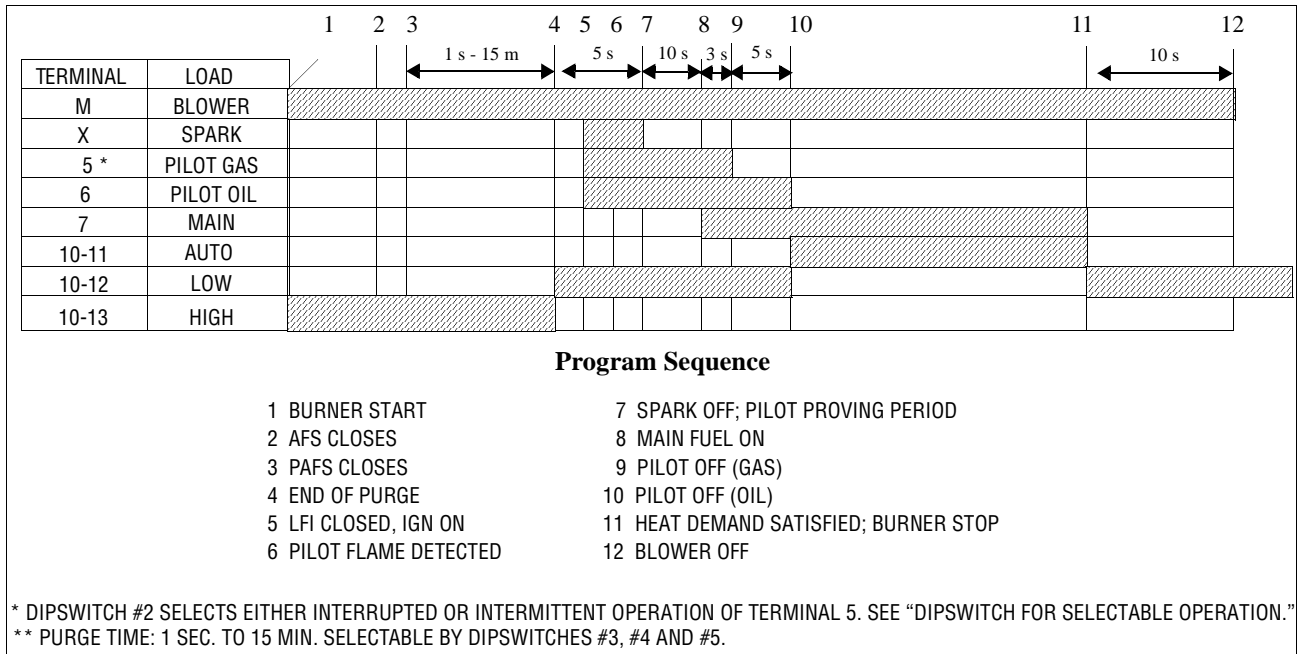

ALARM-LOCKOUT CONDITION

The FIREYE Flame-Monitor control will lockout under the following conditions:

At any time

- Excessive current load at either terminal X, 5, 6, or 7
- Self-diagnostic or failure on chassis amplifier module programming module self-check UV scanner

During burner off time

- False flame signal sensed for more than 30 seconds.

During burner start

- Air flow switch not open within 30 seconds at start*
- Air flow switch not closed 30 seconds after start
- High fire switch not closed within 180 seconds
- False flame sensed for more than 1 second

During prepurge

- Opening of non recycling interlocks (3-P)
- False flame sensed

* Dipswitch #6 enables or disables this requirement, See "Dipswitches for Selectable Operation"

After prepurge

- Low fire interlock not closed within 180 seconds after purge completed (10 seconds minimum).
- Opening of non recycling interlocks (3-P)
- False flame sensed

During burner ignition

- Opening of non-recycling interlocks (3-P)¹
- Pilot flame not detected after pilot trial for ignition time
- Pilot flame failure during pilot proving time
- Flame failure during main burner trial for ignition time

During burner operation

- Opening of non recycling interlocks (3-P)^{*}
- Flame failure¹

CIRCUIT DIAGRAM — FLAME MONITOR™ E210/E211

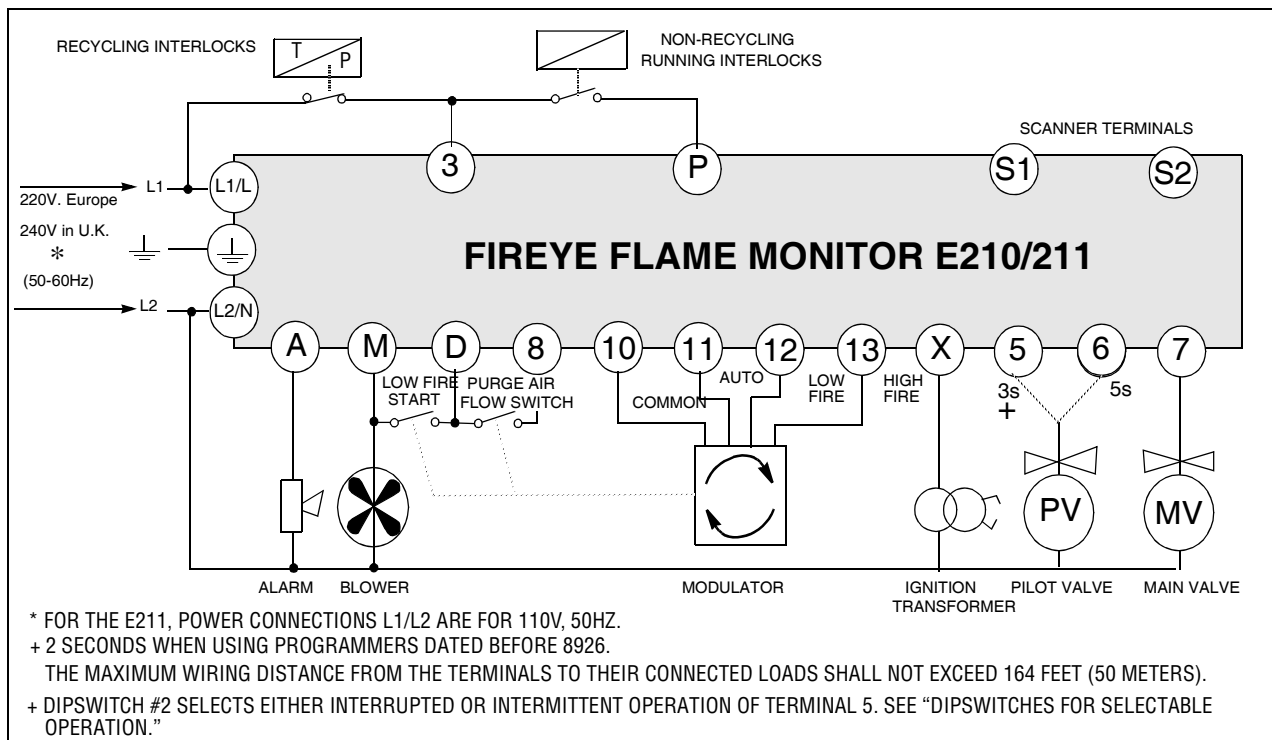

^{*} Dipswitch #1 provides the option to recycle the control instead of going into alarm. See "Dipswitches for Selectable Operation."



MESSAGES

There are two types of messages shown on the ED510 message center:

1. Normal program start-up and stop messages.
2. Alarm - Lockout messages

RUN MESSAGES	DESCRIPTION
STANDBY L1-3 OPEN	The burner has stopped. It is waiting for a demand for heat to burner sequence again.
WAIT STANDBY SAFETY CIRCUIT CLOSED	Dipswitch #6 (3-P Prove Open To Start) is set in the Down position (Enabled). The control is waiting for the safety circuit (3-P) to open before proceeding. Maximum waiting time is 30 seconds before a lockout will occur.*
WAIT PURGE 00:10 SAFETY CIRCUIT OPEN	The control is waiting time (maximum 30 seconds) for the non-recycling interlocks to close.
WAIT PURGE 00:10 D-8 LIMIT OPEN	The control is waiting time (maximum 180 seconds) for the high purge interlock (D-8) to close.
PURGE 00:05 HIGH FIRE PURGE	Prepurge in progress, counting 1 second to 15 minutes.†
HOLD PURGE 00:10 M-D LIMIT OPEN	The control is waiting (maximum 180 seconds) for the modulator to run to the LOW position, waiting for the low fire circuit (M-D) to close (10 second minimum).
PTFI IGNITION TIMING	Unsupervised pilot trial for ignition time (maximum 5 seconds).
PTFI PILOT PROVING	Pilot flame signal during pilot proving time.
MTFI FLAME SIGNAL	Main burner signal during supervised main trial for ignition.
AUTO FLAME SIGNAL	Main burner signal during burner operation.
POST PURGE CYCLE COMPLETE	Post purge timing of 10 seconds (20 seconds in case of flame failure or ignition failure)

* Dipswitch #6 enables or disables this requirement. See "Dipswitches for Selectable Operation."

† Dipswitches #3, #4, and #5 extend the purge timing from 1 sec. up to 15 min. See "Dipswitches for Selectable Operation."



Alarm messages related to the SAFETY CIRCUIT

These messages scroll on the display when an abnormal status of the safety circuit is confirmed. After the post-purge time of 10 seconds, the control trips (lockout). The message remains until the control is reset (even after a power failure).

MESSAGE	DESCRIPTION
ALARM STANDBY 3-P CIRCUIT CLOSED	Dipswitch #6 (3-P Prove Open To Start) is set in the Down position (Enabled). The safety circuit (3-P) was not in the open position at start.*
ALARM STANDBY 3-P CIRCUIT OPEN	The safety circuit (3-P) did not close within 30 seconds after start.
ALARM PURGE 3-P CIRCUIT OPEN	The safety circuit opened during purge time.
ALARM PTFI 3-P CIRCUIT OPEN	The safety circuit opened during pilot trial for ignition (5 seconds).†
ALARM PTFI SAFETY CIRCUIT OPEN	The safety circuit opened during the pilot proving time (10 seconds after Pilot Ignition).†
ALARM MTFI 3-P CIRCUIT OPEN	The safety circuit opened during main burner trial for ignition burner firing time.†
ALARM AUTO 3-P CIRCUIT OPEN	The safety circuit opened during burner operation.†

Alarm messages related to the IGNITION and FLAME FAILURE

These messages scroll on the display when the control and scanner fail to prove the presence of flame. After the post-purge time of 20 seconds, the control trips (lockout). The message remains until the control is reset (even after a power failure).

MESSAGE	DESCRIPTION
ALARM PTFI IGNITION FAILURE	Pilot flame not established within the 5 seconds of the pilot trial for ignition time.
ALARM PTFI FLAME FAILURE	Pilot flame fails during pilot proving time.
ALARM MTFI FLAME FAILURE	Flame failure during trial for ignition main burner.

* Dipswitch #6 enables or disables this requirement. See “Dipswitches for Selectable Operation.”

† Dipswitch #1 has the option to recycle the control instead of going into alarm. See “Dipswitches for Selectable Operation.”



ALARM AUTO
FLAME FAILURE

Flame failure during burner operation.*

Alarm messages related to the FIELD CONDITIONS

These messages scroll on the display when an improper field condition occurs. After the post-purge time of 10 seconds, the control trips (lockout). The message remains until the control is reset (even after a power failure).

MESSAGE	DESCRIPTION
ALARM STANDBY FALSE FLAME	False flame or flame signal detected during burner off cycle for 30 seconds.
ALARM PURGE FALSE FLAME	False flame or flame signal detected during purge time.
ALARM PURGE D-8 LIMIT OPEN	High purge circuit (D-8) not closed within 180 seconds after start of blower.
ALARM PURGE M-D LIMIT OPEN	Low fire circuit (M-D) not closed with 180 seconds after end of purge.

CHECK MESSAGES

These messages are displayed when the “Run-Check” switch is moved to the “Check” position.

CHECK PURGE D-8 HIGH LIMIT	The “Run-Check” switch has been placed in the Check position during purge and will hold indefinitely. The firing rate motor is being driven to the high purge position.
CHECK PURGE M-D LOW LIMIT	The “Run-Check” switch has been placed in the Check position after high fire purge and will hold indefinitely. The firing rate motor is being driven to the low fire position.
CHECK PTFI FLAME SIGNAL 19	The “Run-Check” switch has been placed in the Check position during the pilot trial for ignition period. Flame signal strength is displayed in the upper right hand position. The control will lockout on safety only when no flame signal is sensed for a continuous 30 seconds while the control is in the Check position.
CHECK AUTO LOW FIRE 32	The “Run-Check” switch has been placed in the Check position during the main burner on period, and the firing rate motor is driven to the low fire position. Flame signal strength is displayed in the upper right hand corner.
CHECK STANDBY UNIT ADDRESS 00	The “Check-Run” switch has been placed in the Check position with the operating control circuit (L1-3) open. Every time the Reset button is depressed and held for one second will increment the Unit Address by one. See “UNIT ADDRESS” for additional information.

* Dipswitch #1 has the option to recycle the control instead of going into alarm. See “Dipswitches for Selectable Operation.”



HISTORICAL INFORMATION /SYSTEM SUB-MENUS

At any time the control is powered, the SCRL key will scroll through and display the total number of burner cycles, burner lockouts, and system hours on the bottom line of the ED510 display. The top line will continue to show the current run mode of the control (e.g. PURGE, AUTO, etc.). Following the historical information, the SCRL key will display four (4) System Sub-menus providing the following information and/or functions:

- Lockout History (with burner cycle and burner hour time stamp).
- E320 Message Select (to program messages associated with the E320 Expansion Module).
- Program Setup (to display programmer type, purge timing, FFRT timing, etc.).
- System Information (status of M-D circuit, average pilot flame signal, etc.).

The system sub-menus require the MODE key to gain access to the information associated with each sub-menu. An arrow is displayed in the lower right hand corner of the display to indicate a system sub-menu. Every time the SCRL key is pressed the information is displayed as follows:

AUTO BNR CYCLES	40 385	Number of burner operating cycles. (L1-3 closed).
AUTO BNR LOCKOUTS	40 21	Number of burner lockouts.
AUTO SYS HOURS	40 233	Number of hours the control has been powered.
AUTO ALARM HISTORY	40 >	Sub-menu to display the cause of the last 6 lockouts. The MODE key is required to display the actual lockouts.
AUTO E320 MSG SELECT	40 >	Sub-menu to program the messages associated with the operation of the E320 expansion module. The MODE key is required to enter the sub-menu.
AUTO PROGRAM SETUP	40 >	Sub-menu to display various operating parameters of the programmer and amplifier. The MODE key is required to enter the sub-menu.
AUTO SYSTEM INFO	40 >	Sub-menu to display information pertaining to the operation of the control. The MODE key is required to enter the sub-menu.



ALARM HISTORY

The sub-menu LOCKOUT HISTORY will display the last six (6) lockouts, along with the burner cycle and burner hour when the lockout occurred. When the **MODE** key is pressed, the screen will display the most recent lockout condition and the number of that lockout (e.g. LO #127 represents the 127th lockout of that control). The **SCRL** key will display the Burner Hour, followed by the Burner Cycle when the lockout occurred. The **SCRL** key will advance to the next lockout, and repeat the sequence listed above. The **MODE** key will exit the sub-menu.

PRESS	SCREEN DISPLAYS	DESCRIPTION
SCRL	AUTO 45 ALARM HISTORY >	Scrolling through the historical information. Control has released to auto modulation, flame signal strength = 45.
MODE	AL #158 PURGE D-8 LIMIT OPEN	The last (most recent) lockout condition. This is the 158th lockout of the control.
SCRL	AL #158 PURGE @ BNR HOURS 136	The last lockout occurred after 136 hours of burner operation.
SCRL	AL #158 PURGE @ BNR CYCLE 744	The last lockout occurred on the 744 burner cycle.
SCRL	AL #157 AUTO 3-P INTLK OPEN	The next to last lockout condition. This is the 157th lockout of the control.
MODE	AUTO 45 FLAME SIGNAL	Screen has returned to the run message. Control has released to auto modulation, flame signal strength = 45.

E320 MESSAGE SELECT

The sub-menu “E320 MSG SELECT” will allow the user to modify the lockout alarm messages associated with the operation of the E320 Expansion Module. The various safety limits had to be wired in the exact order that was shown in the E3201 Product Bulletin for the E320. For example, the low water cutoff had to be wired between terminals 31 and 32 of the 60-1950 wiring base of the E320. With the EP style programmers (Engineering code 21 or later), the user will now be able to select which message applies to the individual terminals. The messages associated with the E320 are divided into three (3) groups: Oil Select, Gas Select and Non-recycle.

The **Oil Select** group pertains to the terminals associated with the oil interlocks of the E320. These are terminals 22, 24, 26, and 28.

The **Gas Select** group pertains to the terminals associated with the gas interlocks of the E320. These are terminals 23, 25, and 27.

The **Non-Recycle** group pertains to the remaining limits connected between terminals 3 and P of the E210/E211 control. These are terminals 29, 30, 31, 32, 33, 34, and 35.

The lockout messages associated with the above terminals can be modified via the ED510 Display. The selection of available messages are dependent on each group. For example, the message “Low Oil Pressure” is a selection only for the Oil Select group. The default message for a particular interlock is the standard message for those terminals as indicated in the E-3201 bulletin. For example, the default message for terminal 29 is “COMBUSTION AIR FLOW FAILURE.”

TO MODIFY THE E320 MESSAGES

All three keys: Mode, Reset and Scroll, are used to modify the E320 messages. The Mode key is used to enter or exit the sub-menu associated with the E320 messages. The Scroll key is used to advance through the various terminals or selectable messages. The Reset key is used to modify a terminal message and select a new message. To modify the E320 messages:

Press the Scroll key until the ED510 displays:

E320 MSG SELECT.



Press the Mode key and the screen displays:

E320 TERM #22
LOW OIL TEMPERATURE or programmed message.

Press the Scroll key and the screen displays:

E320 TERM #24
LOW OIL PRESSURE or programmed message.

To change the message, press and hold the Reset key for one (1) second. When the Reset key is released, the screen displays:

MDFY TERM #24
LOW OIL PRESSURE

Press the Scroll key to display the available messages for the particular group being modified. See attached List of available messages for each group.

When the messages displayed is appropriate for the terminals, press and hold the Reset key for one (1) second. When the Reset key is released, the screen displays:

E320 TERM #24.
HIGH OIL PRESSURE or programmed message.

Press the Mode key to exit the E320 Message Sub-menu.

AVAILABLE E320 MESSAGES

The following messages are available for each of the four E320 terminal groups:

GROUP 1 – OIL SELECT

LOW OIL PRESSURE	HIGH OIL TEMPERATURE
HIGH OIL PRESSURE	LOW OIL TEMPERATURE
LOW ATOMIZING TEMPERATURE	AUX OIL

GROUP 2 – GAS SELECT

HIGH GAS PRESSURE	AUX GAS
LOW GAS PRESSURE	

GROUP 3 – NON-RECYCLE

E340 SAFETY INTLK OPEN	HIGH TEMPERATURE
HIGH WATER	AIR FLOW OPEN
LOW WATER	OIL GUN END SWITCH OPEN
HIGH PRESSURE	HIGH STACK TEMPERATURE
F.D. FAN INTLK	BLOWER MOTOR INTLK
I.D. FAN INTLK	AUX NR1
COMBUSTION AIR FLOW FAILURE	AUX NR2
	AUX NR3



USER PROGRAMMED E320 MESSAGES

In addition to selecting the lockout alarm messages for the E320 Expansion Module from a menu selection via the ED510 display, the user can also program any message (up to 40 characters in length) for the individual terminals of the E320 using a dumb terminal (or PC with communication software) and the appropriate interface cables. Refer to bulletin E-3201 for complete details.

PROGRAM SETUP

The sub-menu PROGRAM SETUP allows the user to review the various operational settings of the programmer module (e.g. programmer type, purge timing, etc.). The **MODE** key is used to enter the PROGRAM SETUP sub-menu, and the **SCRL** key is used to advance through the sub-menu.

Press	Screen Displays	Description
SCRL	AUTO 45 PROGRAM SETUP >	SCRL key advances through the historical information until "Program Setup" is displayed. Control has released to auto modulation, flame signal strength = 45.
MODE	AUTO 45 PROGRAMMER EP113	Programmer Type is an EP113.
SCRL	AUTO 45 ENGR CODE NO. 21	Software Engineering code of the programmer module is code 21.
SCRL	AUTO 45 AMP=EUV1 OR ERT1	Amplifier module is an EUV1 or an ERT1.
SCRL	AUTO 45 PURGE TIME 0:30	Purge timing (selected by dipswitches # 3, 4, 5) is 30 seconds.
SCRL	AUTO 45 RECYCLE 3-P = N	The control will lockout (non-recycle) when the running interlock circuit (3-P) is opened during the firing cycle. (selected by dipswitch #1).
SCRL	AUTO 45 TERMINAL 5 = INTMT	Terminal 5 is selected for intermittent operation (selected by dipswitch #2).
SCRL	AUTO 45 PROVE 3-P OPEN=Y	Proven 3-P Open To Start is enabled (selected by dipswitch #6).
SCRL	AUTO 45 FLAME FAIL TIME 1s	Flame Failure Response Time (FFRT) = 1 second (maximum).
SCRL	AUTO 45 UNIT ADDRESS #00	Unit Address is 00. Refer to programmer bulletin to modify Unit Address.
MODE	AUTO 45 FLAME SIGNAL	MODE key returns to run message.



SYSTEM INFO

The sub-menu SYSTEM INFO allows the user to review information pertaining to the operation of the control (e.g. average main flame signal strength, status of the high fire and low fire end switches, etc.). This information can be very helpful when setting the damper linkages on the firing rate motor. The **MODE** key is used to enter the SYSTEM INFO sub-menu, and the **SCRL** key is used to advance through the sub-menu.

Press	Screen Displays	Description
SCRL tion,	AUTO 45 SYSTEM INFO >	SCRL key advances through the historical information until “System Info” is displayed. Control has released to auto modulation. flame signal strength = 45.
SCRL	AUTO 45 AVG. PILOT FLM 22	The average flame signal strength of the pilot flame = 22
SCRL	AUTO 45 AVG. MAIN FLM 40	The average flame signal strength of the main flame = 40.
SCRL be	AUTO 45 SHORT CKTS 0	The total number of short circuits (excessive current) detected on terminals 5, 6, and 7. The short circuit condition must be sensed twice consecutively to be considered a short circuit.
SCRL	AUTO 45 D-8 LIMIT CLOSED	The status of the high fire end switch (D-8) is closed.
SCRL	AUTO 45 M-D LIMIT CLOSED	The status of the low fire end switch (M-D) is closed.
MODE	AUTO 45 FLAME SIGNAL	MODE key returns to run message.

INSTALLATION INSTRUCTIONS

CONTROL INSTALLATION

The control must be assembled before plugging it into the wiring base. When replacing modules, the control must be removed from the wiring base.



CAUTION: Electrical power must be turned off during installation.

To remove the cover place your fingers and palms on each side and pull toward as shown in the diagram. Press down with thumbs while pulling out with your palms and fingers. The cover will snap off and can be snapped back into place easily.

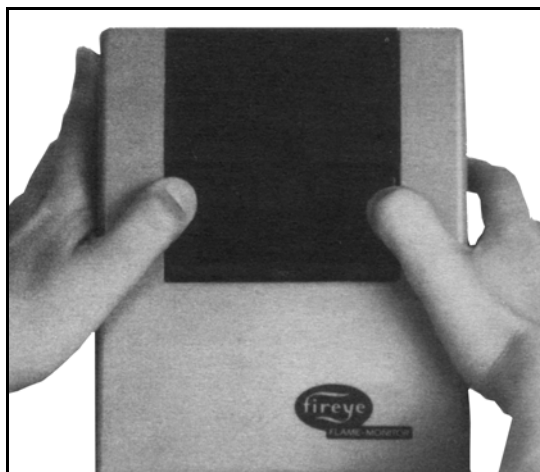
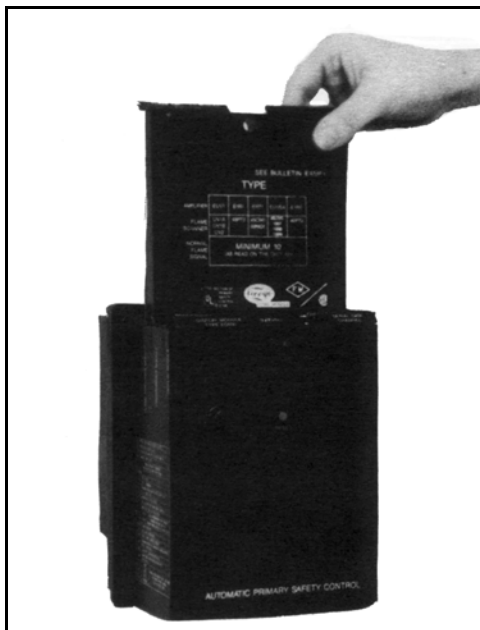

INSTALLING AMPLIFIER MODULE

The flame amplifier module is installed in the third set of guide channels found in the EB720 and EB721 FLAME-MONITOR chassis. It is marked "AMPLIFIER MODULE." Do not force the module into position.

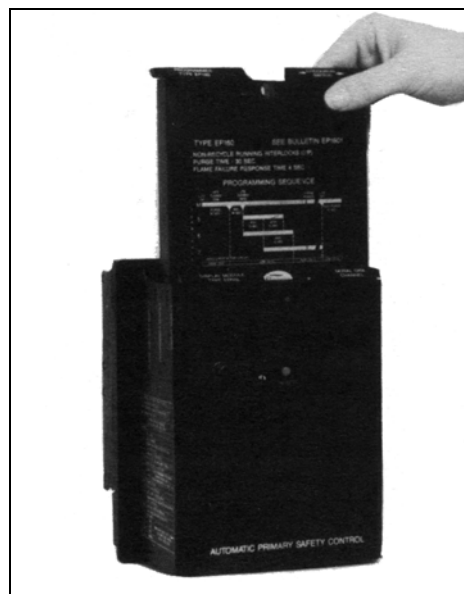

INSTALLING PROGRAMMER MODULE

Fireeye FLAME-MONITOR Programmer Modules are used with Fireeye Series EB720 or EB721 base chassis. To install, simply insert the module into the second slot on the control (marked "Programmer Module" on the side of the chassis). Programmer Modules only fit in the proper slot. They cannot be snapped into place if inserted in the wrong location. **DO NOT FORCE THEM.**

INSTALLING THE DISPLAY MODULE

Slide the bottom of the ED510 display onto the two (2) mounting tabs on the face of the EP113 programmer.

Tilt the ED510 display towards the cover until the mounting tab on top of the ED510 display snaps into position into the opening on the face of the EP113 programmer.

Install the ED580 cable (provided) into the RJ-style connectors on both the ED510 display and EP113 programmer.

INSTALLING THE CONTROL



CAUTION: ELECTRIC POWER MUST BE TURNED OFF DURING INSTALLATION.

1. Check the electrical tabs on the bottom of the chassis – if they are bent out of position, reposition them with your fingers so they are in line as shown here.

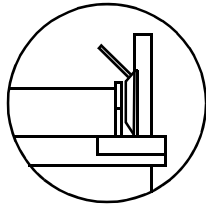

2. Slide the slots at the bottom of the assembled control over the tabs on the wiring base. Push the control into position. Insert a screwdriver through the hole in the top of the control and tighten the retaining screw.
3. Electric power may now be turned on.

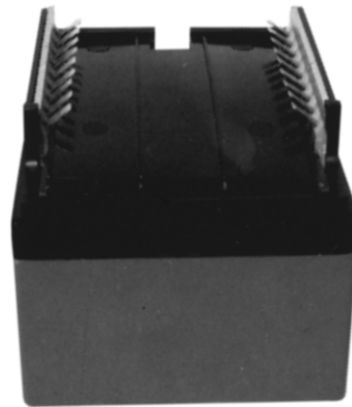

FIELD WIRING

The use of 2.5mm² wires, rated at 600V is appropriate for all field wiring. The wiring base is provided with eighteen (18) numbered terminals plus an earthing screw.

SCANNER INSTALLATION

Infrared scanner installation

A single scanner is used to detect both pilot and main flames. In order for this to happen, the sight pipe on which the scanner mounts must be aimed so that the scanner sights a point at the intersection of main and pilot flames. The scanner must have an unobstructed view of the flame being monitored. To avoid nuisance shutdowns, it is important to avoid sighting hot refractory.

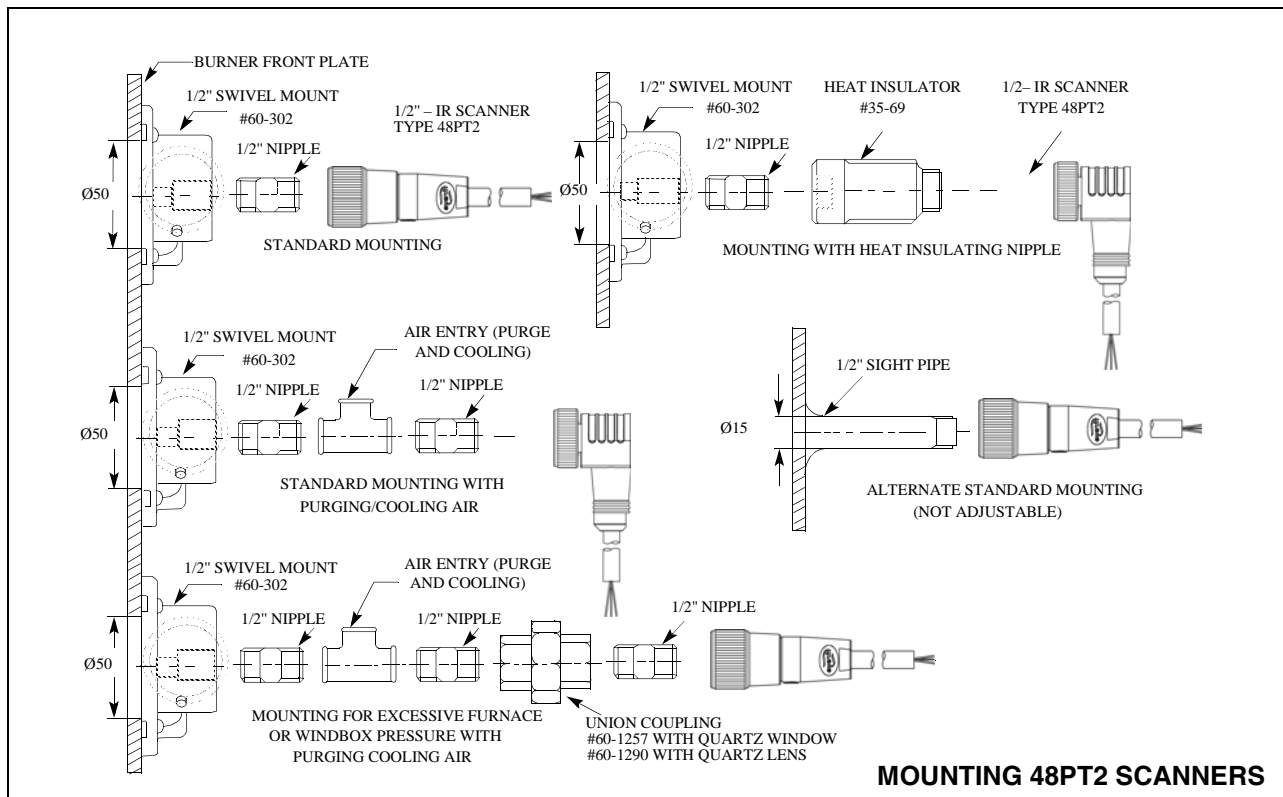

The figure above shows installation instructions for the 48PT2 scanner in various circumstances, taking into account the maximum scanner temperature rating of 52 °C.

- Standard mounting
- Mounting with cooling and/or purging air
- Mounting with heat insulating nipple
- Mounting in case of excessive furnace or windbox pressure

Note: 1/2" nipples and 1/2" TEE pieces are not available from Fireye; these must be purchased locally.

Ultra-violet scanner installation

- Locate the scanner as close as possible to the flame.
- The scanner must not sight the spark directly or any part of the burner that can reflect the spark back to the scanner.
- The maximum UV signal from a flame is found in the first one-third of the visible flame taken from the point where the flame begins. The scanner sight pipe should be aimed at this area.
- On installations having negative pressure combustion chambers, a small hole ($1/8$ " or $3/16$ ") drilled in the sight pipe will help to keep the pipe clean and free from smoke. Two scanners may be installed on one burner if it is necessary to view two areas to obtain reliable detection of the flame. They should be wired in parallel.

NOTE: Two 45UV5 Type scanners cannot be wired in parallel.

TYPICAL UV SCANNER INSTALLATIONS

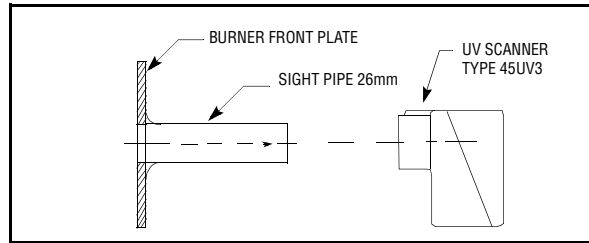

The figures on the next page show different mounting instructions, taking into account the maximum scanner temperature of 100°C

- Standard mounting
- High temperature mounting
- High pressure/temperature mounting

Note: 1" TEE pieces are not available from Fireye; they must be purchased locally.

SCANNER WIRING

Like other FIREYE controls, the FIREYE FLAME MONITOR is protected against short-circuited scanner input terminals. Following recommendations apply for scanner control wiring:

- Keep scanner wiring as short as possible
- Use wires rated for scanner voltage and its ambient conditions (temperature, humidity, oil resistant, flame retardant, etc.).
- Do not run scanner wires in the same conduit as other electrical wires.
- Avoid wire loops and false groundings.
- Do not ground any scanner wire.

Infrared scanner wiring

Infrared scanner type 48PT2 is provided with a flexible conduit. The two wires are to be connected to a coaxial cable via a junction box. Maximum cable length between scanner and control is 30 meters.

Ultra-violet scanner wiring Self-check scanner 45UV5.

The self-check scanner has four wires 1800mm long.

- Two black wires, providing power to shutter drive circuit, to be connected to terminals L1 and N
- Two red wires for flame signal, to be connected to terminals S1 and S2.

Scanner voltage:

- Terminals S1-S2 600 VAC
- Terminals L1-N: Line Voltage above ground:

For extended wiring use standard four conductor cable rated for 600V to be connected via junction to scanner wires. Maximum cable length 50 meters (150 feet).

Other UV scanners

These scanners (UV1A3, UV1A6, UV2, 45UV3) are provided with two wires. Use standard two conductor cable, rated for 600V, to obtain extended wiring via a junction box. Maximum cable length 50 meters (150 feet).

MOUNTING UV1A/UV1B SCANNERS

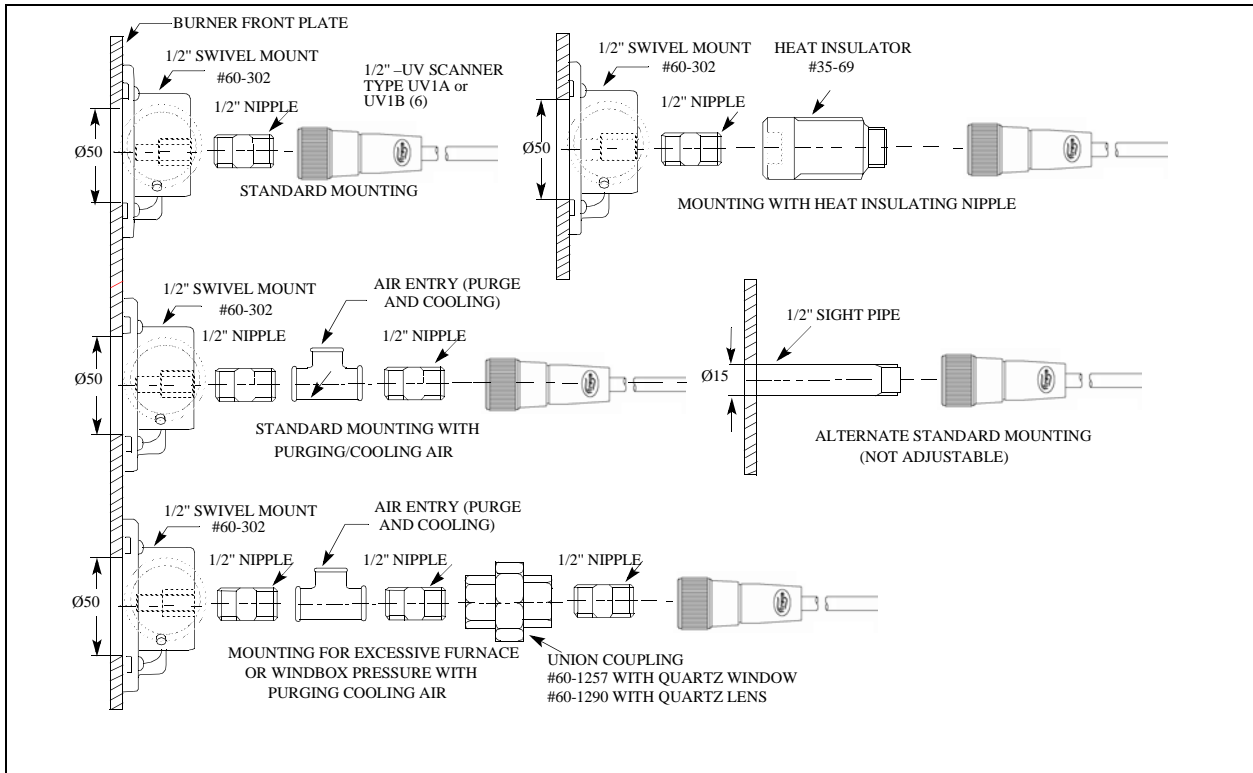

MOUNTING 45UV5 SCANNER

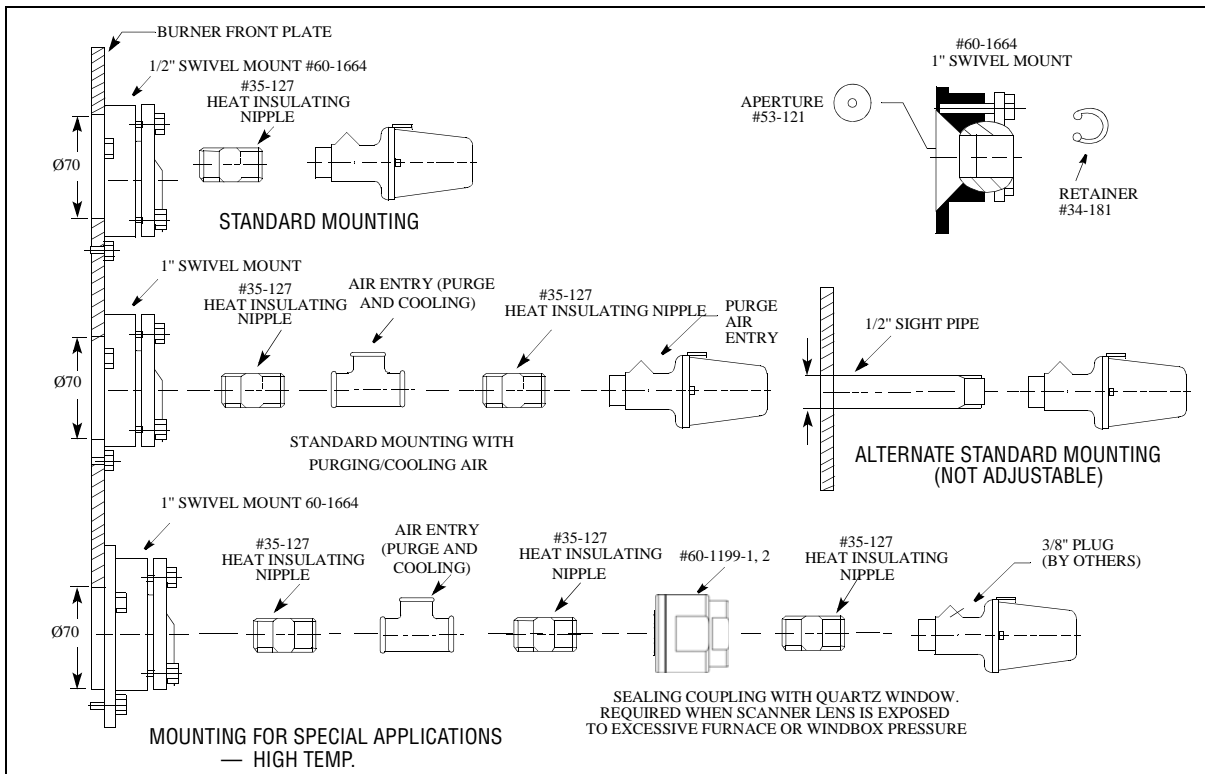

SELECTION OF APPROPRIATE FLAME DETECTOR MODEL 1007

	INFRARED DETECTOR	ULTRA-VIOLET SELF-CHECK DETECTOR	ULTRA-VIOLET DETECTOR
Oil Firing	X	X	X
Gas Firing	X	X	X
Strong Refectory		X	X
Continuous Firing	X	X	
Intermittent Firing	X	X	X

Infrared detectors can be used with almost any single burner application although some difficulty may be encountered with small gas pilots which have a limited infrared output. The infrared radiation passes readily through normal combustion products and dirty surfaces which makes them very reliable in single burner applications. When a single scanner is to be used for detecting both pilot and main flame, the field of view of the scanner must be aimed at the intersection of the pilot and the main flame. This is to insure that a satisfactory signal from the scanner indicates that there is a flame at a point which will be sure to ignite the main flame.

Most flames produce sufficient UV for an ultraviolet detector. Even those flames completely invisible to the eye are easily seen with a UV detector. Since the combustion products of all flames are opaque in the UV region, this detector is also suited to multiple burner installations. The ultraviolet detector is ideally suited to all gas burners or combination gas-oil burners.

The area to scan with an ultra-violet detector is within the first 1/3 length of the flame since this is the major source of UV and also since the combustion products of the flame are opaque in the ultra-violet region.

PROPER FLAME SIGHTING FOR UV SCANNER

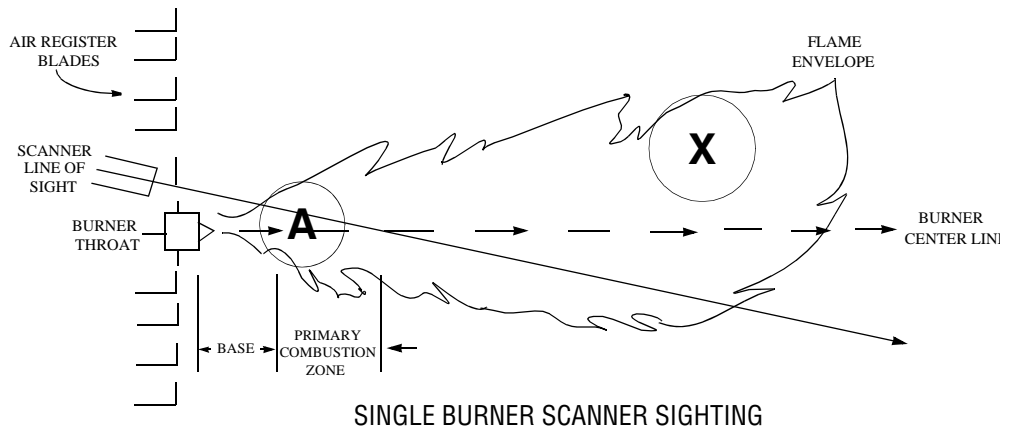

The field of view should be area A. Do not try to scan area X at the outer fringes of the flame. The field of view should include the intersection of the pilot and the main flame so that a signal from the scanner will insure that the pilot is in the proper position to ignite the main flame.

Since the radiated energy from an electric spark ignitor is very rich in the UV region, the field of view should be aimed so that it does not see an electric spark ignitor nor any reflector that is close to the spark.



MAINTENANCE

Type Infrared and Ultra-Violet Scanners

The viewing area of the scanner must be kept clean. Even a small amount of contamination will reduce the flame signal reaching the detector by a measurable amount. Wipe the viewing area routinely using a soft cloth dampened with concentrated detergent.

Flame Signal Strength

Routine observation of the flame signal strength on the display will forewarn of any deterioration in the capability of the flame detector or its application.

Contacts

There are no accessible contacts in the Fireeye Flame Monitor controls. Where contacts are used, their design assures long trouble-free life, when the load circuits are maintained within the published load ratings.

Humidity

In areas of high humidity, the control chassis should be removed and placed in a dry atmosphere when the system is expected to be out of service for an extended period.

COMPONENT DIMENSIONS

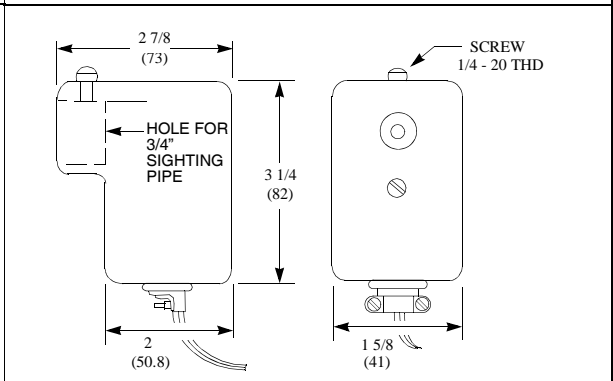
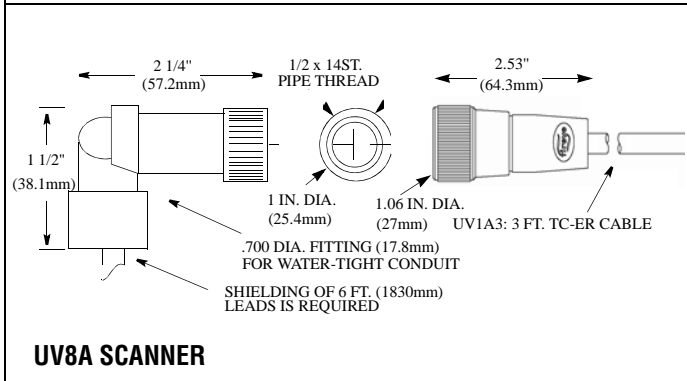
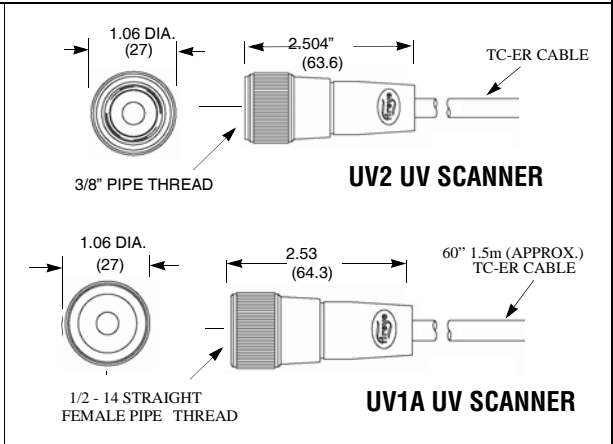
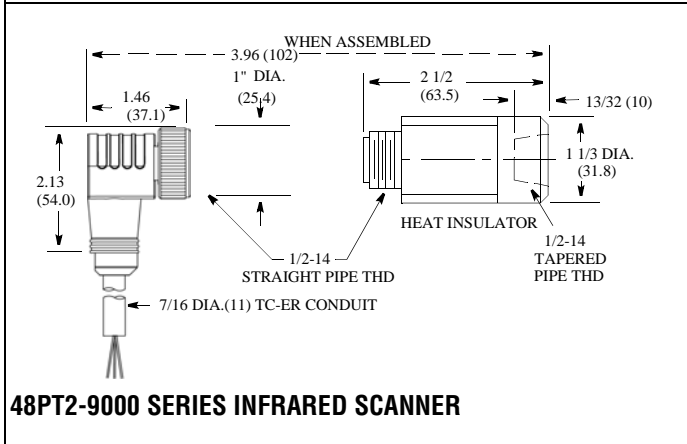
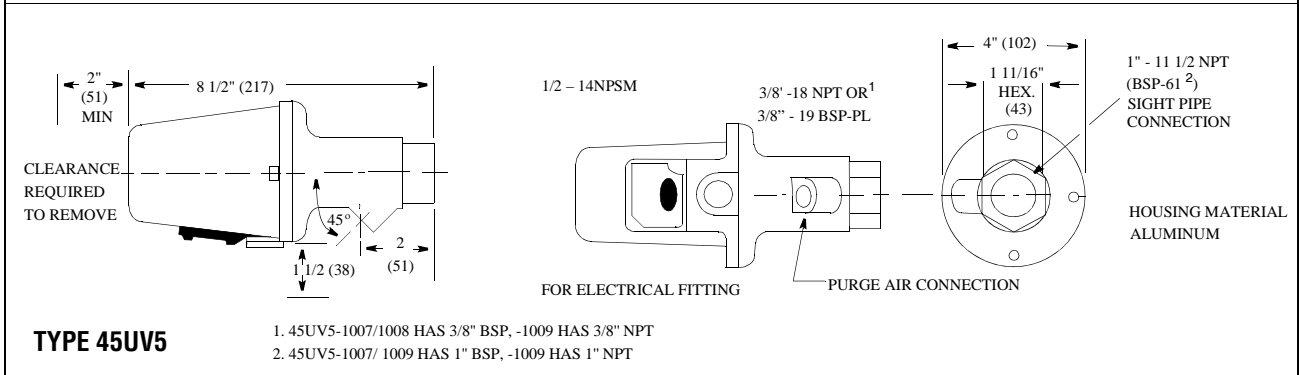
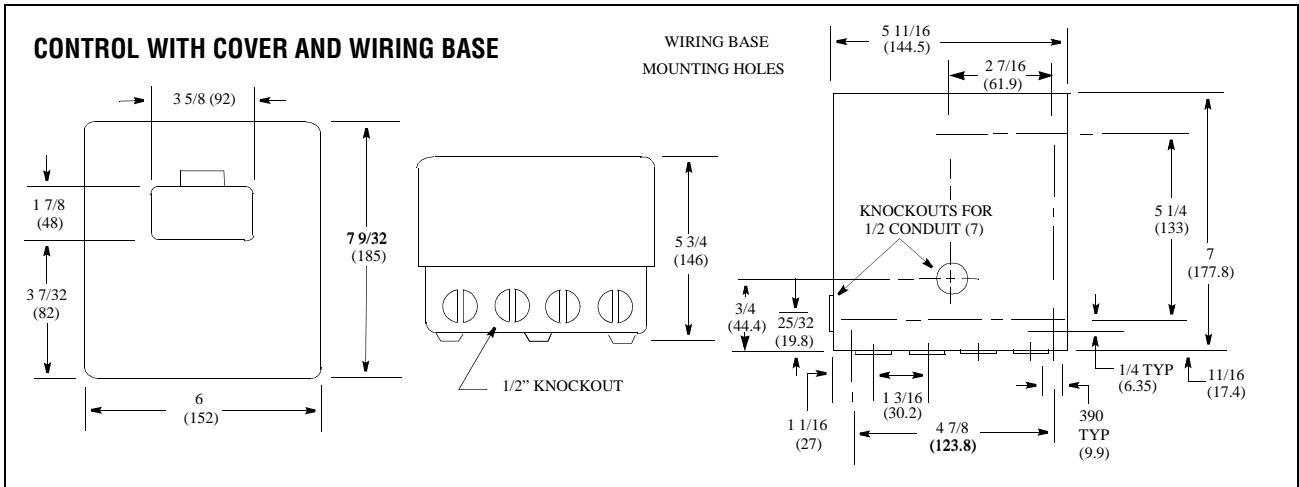









NOTICE

When Fireeye products are combined with equipment manufactured by others and/or integrated into systems designed or manufactured by others, the Fireeye warranty, as stated in its General Terms and Conditions of Sale, pertains only to the Fireeye products and not to any other equipment or to the combined system or its overall performance.

WARRANTIES

FIREEYE guarantees for *one year from the date of installation or 18 months from date of manufacture* of its products to replace, or, at its option, to repair any product or part thereof (except lamps, electronic tubes and photocells) which is found defective in material or workmanship or which otherwise fails to conform to the description of the product on the face of its sales order. **THE FOREGOING IS IN LIEU OF ALL OTHER WARRANTIES AND FIREEYE MAKES NO WARRANTY OF MERCHANTABILITY OR ANY OTHER WARRANTY, EXPRESS OR IMPLIED.** Except as specifically stated in these general terms and conditions of sale, remedies with respect to any product or part number manufactured or sold by Fireeye shall be limited exclusively to the right to replacement or repair as above provided. In no event shall Fireeye be liable for consequential or special damages of any nature that may arise in connection with such product or part.



® FIREEYE
3 Manchester Road
Derry, New Hampshire 03038 USA
www.fireeye.com

E-2101
MAY 12, 2011
Supersedes November 7, 2008